

## CONGRATULATIONS!

You have made an excellent choice with your new Vespa® ET4 motorscooter.

Before you set off, be sure to read this handbook from cover to cover.

You will find all the instructions you need to get to know your new vehicle thoroughly and use it correctly.

Reading through the numerous features and top level specifications described in the handbook will help

you get a feel for your new vehicle, providing the basis  
for many years of riding pleasure.



Your vehicle has been manufactured by the company Piaggio & C. S.p.A. at its factory in Pontedera, Italy.

[www.vespausa.com](http://www.vespausa.com)

# THE HANDBOOK

The instructions in this handbook are designed to provide a clear and simple guide to the use of your new vehicle. The handbook contains information regarding maintenance work and periodic checks that must be carried out by Vespa Dealers or Authorized Piaggio/Vespa Service Centers.

You will also find instructions for several simple repair jobs you can do yourself. All operations not explicitly described in the handbook require the use of special tools and/or specific technical skills and should be performed exclusively by Vespa Dealers or Authorized Piaggio/Vespa Service Centers.

Areas of text highlighted with the symbols shown on the next page contain important information regarding use of the vehicle and road safety.

---

2

## SYMBOLS FOR THE CORRECT USE OF YOUR NEW VEHICLE

*The symbols on this page are important.*

*They highlight areas of the handbook that deserve special attention.*

*The three symbols are distinctive so that information can be located quickly.*



### **PERSONAL SAFETY** WARNING

Failure to observe these instructions will result in a serious risk of personal injury or even death.



### **ENVIRONMENTAL RESPECT**

Sections marked with this symbol indicate the correct use of the vehicle in full respect of your natural surroundings.



### **VEHICLE SAFETY** CAUTION

Failure to observe these instructions will result in the risk of serious damage to the vehicle and, in certain cases, may invalidate the warranty.

---

3

## GENERAL SAFETY RULES

### FOREWORD

This manual is an important and integral part of your vehicle. Keep it with your vehicle at all times and when vehicle is resold.

Piaggio has prepared this manual to provide the owner with correct and current information. However, since Piaggio constantly improves the design of its vehicles, there may be slight discrepancies between your vehicle and the material given in this manual.

If you have any questions about your vehicle, contact your local Vespa Dealer, as he will have the very latest technical information available from the factory or call toll free:

1-866-4-PIAGGIO

For tests and repairs not expressly described in this manual, to purchase Piaggio genuine spare parts, accessories, and other products, or for help with specific problems, please contact your local Vespa Dealer or Authorized

Piaggio/Vespa Service Center. These professionals will be able to promptly and accurately help you. Thank you for choosing Piaggio. Have a great ride!

### CARBON MONOXIDE

If it is necessary to let the engine run in order to carry out some work, make sure that the area in which you are operating is properly ventilated. Never run the engine in enclosed spaces. If it is necessary to work indoors, use an exhaust evacuation system.



### WARNING

The exhaust fumes contain carbon monoxide, a poisonous gas that can cause loss of consciousness and even death.



### FUEL WARNING

Gasoline is extremely flammable and in some conditions can become explosive.

Therefore, it is necessary to refuel and carry out maintenance operations involving the fuel system in a well-ventilated area with the engine off.

Do not refuel or perform any maintenance on the fuel system with the engine running.

Do not smoke while refueling or near fuel vapors.

Never allow any portion of the fuel system to come in contact with open flames, sparks and/or other heat sources.

Be careful to avoid spilling fuel when you are refueling. Spilled fuel could ignite when it contacts hot engine or exhaust system surfaces. If you accidentally spill some fuel, make sure that it is wiped up or completely evaporated before starting the vehicle.

Since gasoline expands in the fuel tank when the vehicle is sitting in the open sun, never fill the tank completely to the brim. Leave at least one inch of expansion space.

Avoid any contact of the fuel with your skin, and avoid inhalation of fuel vapors. Do not ever attempt to siphon fuel from one container to another using your mouth as suction for a siphon hose. Use a manual pump or a similar system.



### WARNING

Gasoline is poisonous and carcinogen and contains chemical substances that cause birth defects and other reproductive problems. If gasoline should be accidentally spilled on the skin or clothes, immediately wash it off with soap and water and change clothes.

Should you accidentally spill gasoline in your eyes, flush with a large quantity of water and immediately contact a health professional. Should you accidentally get gasoline into your mouth, do not induce vomiting. Drink a large quantity of milk or clear water and immediately contact a health professional.

If your vehicle overturns, it may leak gasoline which is extremely flammable. Flames or sparks may ignite the gasoline, which will not only destroy the vehicle but also could do serious property damage to surrounding property and cause serious injuries or even death.

DISPOSE OF UNWANTED GASOLINE PROPERLY, DO NOT DUMP IT INTO STORM DRAINS, SINKS OR TOILETS.

KEEP GASOLINE AWAY FROM CHILDREN.

## GENERAL SAFETY RULES

### **HOT COMPONENTS WARNING**

The engine and all parts of the exhaust system, as well as the braking system, become very hot and remain hot for some time after the motorcycle and the engine are stopped.

Before handling any component of your motorcycle after riding, ensure that it has cooled sufficiently to be safe to handle.

### **HIGH VOLTAGE CABLE WARNING**

Starting the engine, while keeping in your hands the high voltage cable disconnected from the spark plug, is extremely dangerous.

### **COOLING FAN WARNING**

Keep your fingers and other body parts, as well as any other object, well clear of the cooling fan when the engine is running. Failure to observe this warning can damage your engine, as well as cause serious injury to you.

### **REAR WHEEL WARNING**

Be very careful to keep your fingers, all your other body parts, and any object well clear of the rear wheel while the engine is running and the vehicle is resting on its stand. Failure to observe this warning can lead to serious personal injury, as well as damage to your engine.

### **SHOCK-ABSORBERS WARNING**

Do not disassemble the front and rear shock-absorber. The shock-absorbers have preloaded springs. Disassembly can cause serious injury and even death.

### **USED ENGINE OIL WARNING**

Use latex gloves for the maintenance operations that require contact with used oil.

Used engine oil may cause skin cancer if repeatedly left in contact with the skin for prolonged periods. Although this is unlikely unless you handle used oil on a daily basis, it is advisable to thoroughly wash your hands with soap and water after handling used oil.

KEEP OIL AWAY FROM CHILDREN.

6

### **BRAKE FLUID CAUTION**

Brake fluid is extremely poisonous. Never allow brake fluid to be ingested or swallowed. Should brake fluid accidentally be swallowed, drink large quantities of milk or pure water and immediately seek professional medical assistance. Brake fluid is highly destructive to skin and eye tissue. Should you accidentally spill brake fluid on yourself, remove the contaminated clothing, wash your body with soap and warm water immediately and seek professional medical assistance. Should you accidentally splash brake fluid into your eyes, flush with a large quantity of cool, clear water and immediately seek professional medical assistance.

KEEP BRAKE FLUID AWAY FROM CHILDREN.

### **BATTERY HYDROGEN GAS AND ELECTROLYTE WARNING**

Vehicle batteries give off noxious and explosive gases; keep cigarettes, flames and sparks away from the battery.

Provide adequate ventilation when operating or recharging the battery. During recharging or use, make sure that the room is properly ventilated and avoid inhaling the gases released during the recharging.

The battery contains sulphuric acid (electrolyte). Contact with the skin or eyes may cause serious burns. Always wear protective clothing, rubber gloves, and tight fitting goggles or a face shield when working around the battery, especially when filling the battery with either water or electrolyte.

In case of contact with the skin, flush immediately with plenty of water. In case of contact with the eyes, flush with plenty of water for at least 15 minutes. Immediately consult a health professional.

The electrolyte is poisonous.

If the electrolyte is accidentally swallowed, drink large quantities of water or milk and then follow with milk or magnesia, beaten egg or vegetable oil. Immediately consult a health professional.

KEEP AWAY FROM CHILDREN.

7

## GENERAL SAFETY RULES

### PRECAUTIONS GENERAL ADVICE



#### WARNING

Before starting the engine, carefully read this manual and in particular the chapters "PERSONAL SAFETY - ENVIRONMENTAL RESPECT - VEHICLE SAFETY" see p. 3.

Your safety and that of those around you depends not only on your skill as a rider, but also your knowledge about your motorscooter and about riding safely. Therefore, it is essential that you do not operate your vehicle on public streets until you have received instructions from a qualified safety organization such as the Motorcycle Safety Foundation, and are properly trained and licensed.

### REPORTING OF DEFECTS THAT AFFECT SAFETY

If you believe that your motorscooter has a defect which could cause an accident or could cause injury or death, you should immediately inform the National Highway Traffic Safety Administration (NHTSA) in addition to notifying Piaggio by calling toll free: 1-866-4-PIAGGIO. If NHTSA receives similar complaints, it may open an investigation, and if it finds that a safety defect exists in a group of motorscooters, it may order a recall and remedy campaign. However, NHTSA cannot become involved in individual problems between you, your Dealer, or Piaggio. To contact NHTSA, you may either call the Auto Safety Hotline toll free at 1-800-424-9393 (or 366-0123 in the Washington, D.C. area) or write to: NHTSA, U.S. Department of Transportation, Washington, D.C. 20590.

You can also obtain other information about motorcycle safety from the Hotline.

### ROAD REGULATIONS AND USE OF THE MOTORSCOOTER

Rules of the road vary from country to country or state to state. It is essential that you understand in advance the rules of the road of the country or of the state in which your vehicle will be used.



#### WARNING

This motorscooter has been designed and produced for use on even and paved roads or surfaces only.

Do not use the motorscooter on unpaved surfaces, in order to avoid overturning or other accidents.



#### WARNING

Piaggio recommends you not to ride your motorscooter on state or national highways, freeways or expressways.

### NOISE EMISSION WARRANTY

Piaggio warrants that this exhaust system, at the time of sale, meets all applicable U.S. EPA Federal noise standards. This warranty covers the first person who buys this exhaust system for purposes other than resale, and to all subsequent buyers.

Warranty claims should be directed to: Piaggio USA, Inc.

20003 South Rancho Way,  
Rancho Dominguez, CA 90220  
USA

Phone Number: 1-866-474-2444

### INFORMATION ON THE NOISE AND EXHAUST GAS EMISSION CONTROL SYSTEM

#### ORIGIN OF THE EMISSIONS

The combustion process produces carbon monoxide and hydrocarbons. The control of hydrocarbons is very important, because under certain conditions they react to exposure to sunlight and produce photochemical smog. Carbon monoxide does not react in the same way, but it is toxic and poisonous. Piaggio utilizes "lean" carburetor settings to reduce the production of carbon monoxide and hydrocarbons.

#### EXHAUST EMISSION CONTROL SYSTEM

The Exhaust Emission Control System requires "lean" carburetor settings and no adjustments should be made, except idle speed adjustments by

means of the appropriate screw.

The exhaust emission control system is separate from the crankcase emission control system.

#### CRANKCASE EMISSION CONTROL SYSTEM

The engine is equipped with a closed crankcase system, in order to avoid discharging the crankcase emissions into the atmosphere. The blow-by gas is returned to the combustion chamber through the air cleaner and the throttle valve.

#### EVAPORATIVE EMISSION CONTROL SYSTEM

In California vehicles are equipped with an evaporative emission control system consisting of an activated carbon canister with the relevant pipes. This system prevents the escape of fuel vapours from the fuel tank.

## GENERAL SAFETY RULES

### **TAMPERING WARNING**

Tampering with the noise control system is prohibited. Federal law prohibits the following acts:

- a) Removal or rendering inoperative by any person other than for purposes of maintenance, repair, or replacement, any device or element of design incorporated into any new motorscooter for the purpose of noise control prior to its sale or delivery to the ultimate purchaser or while it is in use, or
- b) Use of the motorscooter after such device or element of design has been removed or rendered inoperative by any person. Among those acts presumed to constitute tampering are the acts listed below:
  - a) Removal of, or puncturing the muffler, baffles, header pipes or any

other component which conducts exhaust gases.

- b) Removal or puncturing of any part of the intake system.
- c) Lack of proper maintenance.
- d) Replacement of any moving part of the motorscooter, or parts of the exhaust or intake system, with parts other than those specified by Piaggio.

### **CAUTION**

The vehicle should be checked for repair or replacement if the motorscooter noise has increased significantly through use. Otherwise, the owner may become subject to penalties under state and local ordinances.

### **PROBLEMS THAT MAY AFFECT THE MOTORSCOOTER EMISSIONS**

If any of the following symptoms are observed, immediately have your motorscooter inspected and repaired by your Vespa Dealer or Authorized Piaggio/Vespa Service Center.

Symptoms:

- Difficulty starting or stalling after starting.
- Irregular idle.
- Misfiring or backfiring during acceleration.
- After-burning (backfiring).
- Poor engine performance, degraded handling, or poor fuel economy.

10

### **PROTECTIVE CLOTHING**

For your safety, we strongly recommend that you always wear an approved motorcycle helmet, eye protection, boots, gloves, long pants, and a long-sleeved shirt or jacket whenever you ride. Although complete protection is not possible, wearing proper gear can reduce the chance of injury. See your Vespa Dealer for stylish, comfortable and effective riding gear suggestions.

### **HELMETS AND EYE PROTECTION**

Your helmet is your most important piece of riding gear because it offers the best protection against head injuries. A helmet should fit your head comfortably and securely. A brightly colored helmet can make you more noticeable in traffic, as can reflective strips.

An open-face helmet offers some protection, but a full-face helmet offers more. Always remember to properly fasten your crash helmet. Regardless of the style, look for a DOT (Department Of Transportation) sticker in any helmet you buy (USA only), and always wear a face shield or goggles to protect your eyes and help your vision.

### **ADDITIONAL RIDING GEAR**

In addition to a helmet and eye protection, we also recommend:

- Properly fitted boots with non-slip soles to help protect your feet and ankles.
- Leather gloves to keep your hands warm and help prevent blisters, cuts, burns and bruises.
- A motorcycle riding suit or jacket for comfort as well as protection.

Brightly colored and reflective clothing can help make you more noticeable in traffic. Be sure to avoid loose clothes that could get caught on any part of your motorscooter.

11

## POSITION OF THE WARNING ADHESIVE LABELS

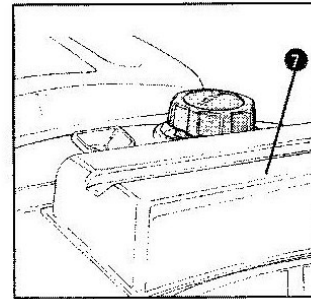
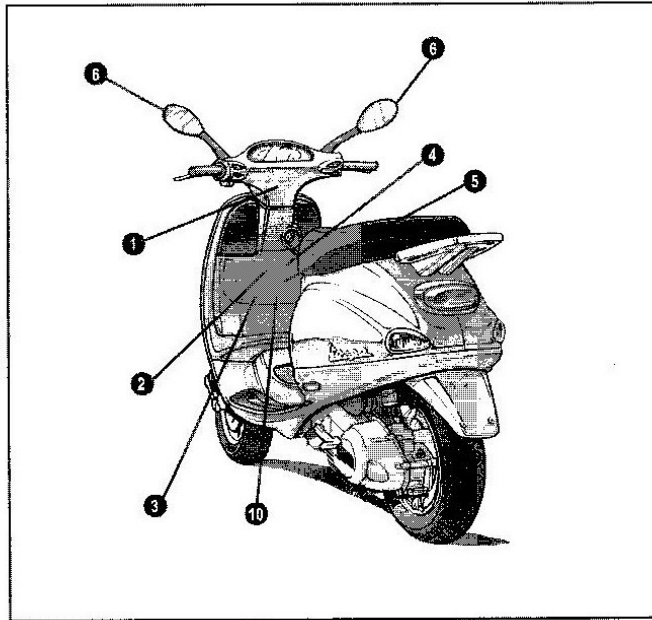

12

Ref.	Description
1	<p><b>WARNING!</b></p> <ul style="list-style-type: none"> <li>Wear a helmet, eye protection and bright protective clothing.</li> <li>Don't ride after consuming alcohol or other drugs.</li> <li>Road users on slippery surfaces, on hilly terrain or when visibility is reduced.</li> <li>Read owner's manual carefully.</li> <li>Failure of follow these warnings can lead to an accident and serious injuries or death.</li> <li>USE UNLEADED FUEL, MINIMUM OCTANE RATING IS 90/93, METHOD 44</li> <li>See owner's manual for the correct meaning and maintenance of the labels.</li> </ul>
2	<p><b>VEHICLE EMISSION CONTROL INFORMATION</b></p> <p>FACILE INSPECTION SYSTEM</p> <p>ENGINE MODEL: SP10C2 150 cc          THIS VEHICLE CONFORMS TO U.S. EPA AND CALIFORNIA REGULATIONS APP. CABLE FOR 2001 MODEL YEAR NEW MOTORCYCLES AND IS CERTIFIED TO 10% COOL ENGINE FAMILY DESIGN BY BENDAHN (FACILE) IN CALIFORNIA ENGINE EMISSION CONTROL SYSTEM.</p> <p>ENGINE MODEL: SP10C2 150 cc          IGNITION TIMING: 10° AT 1500 RPM; 12° AT 2000 RPM          OIL LEVEL: 1.5 L (39.4 fl. oz.)          OIL TYPE: SAE 10W-40          VALVE CLEARANCE: INLET 0.084 mm (0.0033 in.)          OVERLAP: 55.00 mm (2.165 in.)          SPARK PLUG: CHAMPION R45R          SPARK PLUG GAP: 0.228-0.303 mm (0.009-0.012 in.)          FUEL SYSTEM: CARBURETOR, INJECTOR METHOD 44          OIL ENGINE OIL VISCOSITY SAE 10W-40          PIAGGIO &amp; C. SpA PORTOFINO, Italy</p>
3	<p><b>MOTORCYCLE NOISE EMISSION CONTROL INFORMATION</b></p> <p>THIS 2001 VESPA 150 MOTORCYCLE, 828540 MEETS EPA NOISE EMISSION REQUIREMENTS OF 80 dBA AT 7125 RPM BY THE FEDERAL TEST PROCEDURE. MODIFICATIONS WHICH CAUSE THIS MOTORCYCLE TO EXCEED FEDERAL NOISE STANDARDS ARE PROHIBITED BY FEDERAL LAW. SEE OWNER'S MANUAL.</p>

Ref.	Description
4	<p>Esmp. Family "PVM0017M19" - Hose Routing Diagram          Piaggio &amp; C. S.p.A.</p> <ul style="list-style-type: none"> <li>A) Fuel Tank</li> <li>B) 2-Way &amp; Roll-Over valves</li> <li>C) Carburetor</li> <li>D) 1-Way purge control valve</li> <li>E) Purge valve</li> <li>F) Carburetor</li> <li>G) Vacuum operated fuel valve</li> </ul> <ul style="list-style-type: none"> <li>1) Fuel tank vent line</li> <li>2) Vacuum line</li> <li>3) Feed line</li> <li>4) Carburetor vent line</li> <li>5) Purge line</li> </ul>
5	<p><b>WARNING!</b></p> <p>Never install accessories or replacement parts not approved by PIAGGIO &amp; C. SpA as original equipment. This may degrade the handling and safety of your motorcycle, and can cause an equal or worse accident and serious injury or even death. The handling and safety of any motorcycle is adversely affected by the addition of any load carrying accessory. See owner's manual.</p>
6	<p>OBJECTS IN MIRROR ARE CLOSER THAN THEY APPEAR</p>
7	<p><b>WARNING!</b></p> <p>NEVER FILL FUEL TANK TO FULL LEVEL BUILT INTO FILLER NECK. IF FUEL IS OVERFILLED, HEAT MAY CAUSE FUEL TO EXPAND AND FLOW INTO EVAPORATIVE EMISSION CONTROL SYSTEM RESULTING IN HARMFUL EMISSIONS AND ENGINE WEAR/DAMAGE.</p>

13

## POSITION OF THE WARNING ADHESIVE LABELS

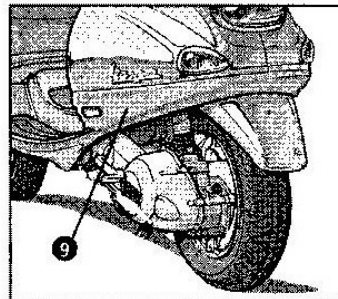
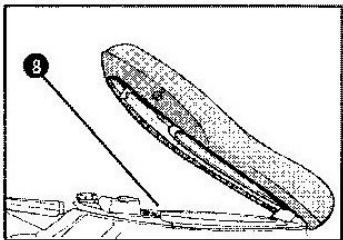

14

Ref.	Description																												
8	<p><b>WARNING!</b></p> <p>Batteries contain sulfuric acid which can cause severe injuries. Avoid contact with skin eyes or clothing. DRESSING: Flush with water. <b>OFFENSIVE:</b> Drink large quantities of water or milk. Follow with milk or magnesium. Obtain aid or help of a physician immediately. First Aid: Flush with water for 15 minutes and get prompt medical attention.</p> <p><b>KEEP OUT OF REACH OF CHILDREN</b></p> <p>Batteries produce explosive gases. Keep sparks, flames, cigarettes away. Charge only in well-ventilated space. Always wear protective goggles when working around batteries. Always connect the battery with care.</p> <p>Failure to heed this warning will cause corrosion of an electrical system.</p>																												
9	<p><b>WARNING!</b></p> <p>Kick-starter lever.</p> <p>Improper use can cause severe injuries. See owner's manual.</p>																												
10	<p><b>WARNING!</b></p> <p>Do not use any tire after the date shown below unless it is approved by PASCOR &amp; C. S.P.A. Marked always for inflation. Do not use any tire with less than 1/32" (2 mm) tread remaining. Do not repair any tire, not use a repaired tire. Do not ride your motorcycle equipped with an unbalanced tire. Failure to follow these warnings can lead to an accident and serious injuries or death. See owner's manual.</p> <table border="1"> <thead> <tr> <th colspan="4">Front tire</th> </tr> </thead> <tbody> <tr> <td>Front Left</td> <td>Front Right</td> <td>Part No.</td> <td>Eq.204 - 14F 53L</td> </tr> <tr> <td>Part No.</td> <td>Part No.</td> <td>Part No.</td> <td></td> </tr> <tr> <td>1.9 112 21</td> <td>1.9 112 21</td> <td>1.9 112 21</td> <td></td> </tr> <tr> <th colspan="4">Rear tire</th> </tr> <tr> <td>Driver</td> <td>Passenger</td> <td>Part No.</td> <td>1.0275 - 14F 54L</td> </tr> <tr> <td>1.9 112 21</td> <td>1.9 112 21</td> <td>Part No.</td> <td></td> </tr> </tbody> </table>	Front tire				Front Left	Front Right	Part No.	Eq.204 - 14F 53L	Part No.	Part No.	Part No.		1.9 112 21	1.9 112 21	1.9 112 21		Rear tire				Driver	Passenger	Part No.	1.0275 - 14F 54L	1.9 112 21	1.9 112 21	Part No.	
Front tire																													
Front Left	Front Right	Part No.	Eq.204 - 14F 53L																										
Part No.	Part No.	Part No.																											
1.9 112 21	1.9 112 21	1.9 112 21																											
Rear tire																													
Driver	Passenger	Part No.	1.0275 - 14F 54L																										
1.9 112 21	1.9 112 21	Part No.																											

15



## CALIFORNIA EVAPORATIVE EMISSION SYSTEM

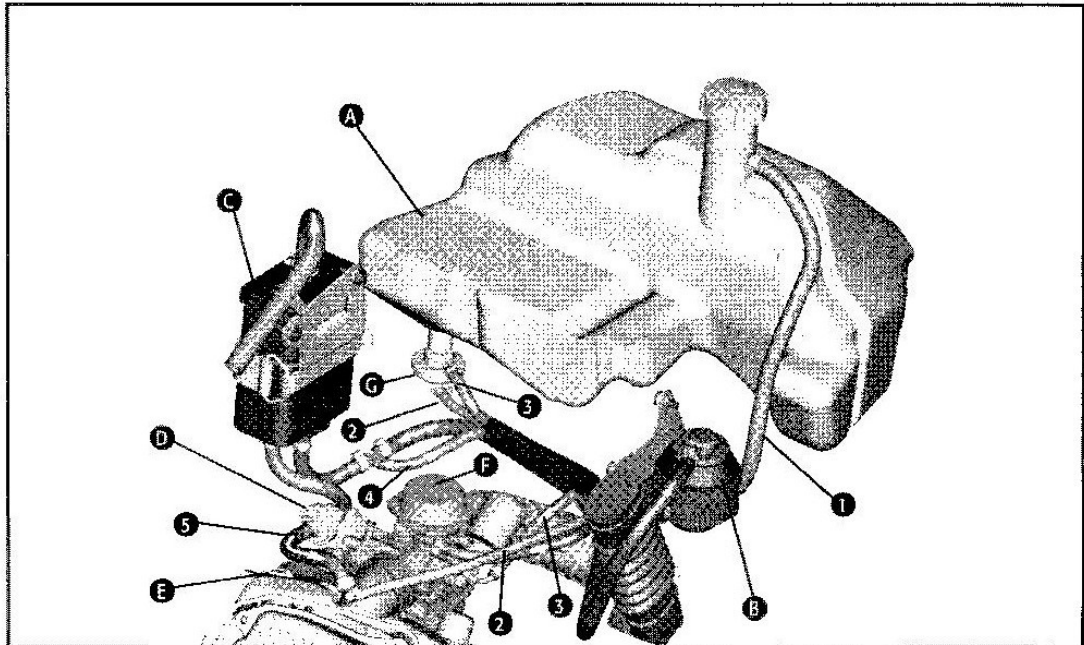

16

This system consist of:

- A) Fuel Tank
- B) 2 - Way & Roll-Over valves
- C) Canister
- D) 1 - Way purge control valve
- E) Purge valve
- F) Carburetor
- G) Vacuum operated fuel valve

- 1) Fuel tank vent line
- 2) Vacuum line
- 3) Feed line
- 4) Carburetor vent line
- 5) Purge line

17

### **YOUR WARRANTY RIGHTS AND OBLIGATIONS**

The California Air Resources Board and Piaggio & C. S.p.a. (hereinafter Piaggio) are pleased to explain the emission control system warranty on your 2001 and later motorscooter. In California new motor vehicle must be designed, built and equipped to meet the State's stringent anti-smog standards. Piaggio must warrant the emission control system on your motorscooter for the periods of time listed below provided there has been no abuse, neglect or improper maintenance of your motorscooter.

Your emission control system may include parts such as the carburetor or fuel-injection system, the ignition system, catalytic converter and engine computer. Also included may be hoses, belts, connectors and other emission-related assemblies.

Where a warrantable condition exists, Piaggio will repair your motorscooter at no cost to you, including diagnosis, parts and labor.

### **MANUFACTURER'S WARRANTY COVERAGE**

Class I motorcycle or motorscooter (50-169 cc): for a period of use of five (5) years or 12,000 kilometers (7,456 miles), whichever first occurs.

Class II motorcycle or motorscooter (170 to 279 cc): for a period of use of five (5) years or 18,000 kilometers (11,185 miles), whichever first occurs.

Class III motorcycle or motorscooter (280 cc and larger): for a period of use of five (5) years or 30,000 kilometers (18,641 miles), whichever first occurs.

If an emission-related part on your motorscooter is defective, the part will be repaired or replaced by Piaggio. This is your emission control system DEFECTS WARRANTY.

### **OWNER'S WARRANTY RESPONSIBILITIES**

- As the motorscooter owner, you are responsible for the performance of the required maintenance listed in your owner's manual. Piaggio recommends that you retain all receipts covering maintenance on your motorscooter, but Piaggio cannot deny warranty solely for the lack of receipts or for your failure to ensure the performance of all scheduled maintenance.
- You are responsible for presenting your motorscooter to a Vespa Dealer as soon as a problem exists. The warranty repairs should be completed in a reasonable amount of time, not to exceed 30 days.
- As the motorscooter owner, you should be aware that Piaggio may deny warranty coverage if your motorscooter or a part has failed due to abuse, neglect, improper maintenance or unapproved modifications.

If you have any questions regarding your warranty right and responsibilities, you should contact Piaggio USA.

**20003 South Rancho Way,  
Rancho Dominguez, CA90220  
USA**

**Phone Number: 1-866-474-2444**

Piaggio & C. S.p.a., Viale Rinaldo Piaggio, 25, 56025 Pontedera (PISA) Italy (hereinafter Piaggio) warrants that each new 2001 and later Piaggio motorscooter, that includes as standard equipment a headlight, taillight and stoplight, and is street legal:

A) Is designed, built and equipped so as to conform at the time of initial retail purchase with all applicable regulations of the United States Environmental Protection Agency, and the California Air Resources Board; and

B) Is free from defects in material and workmanship which cause such motorscooter to fail to conform with applicable regulations of the United States Environmental Protection Agency or the California Air Resources Board for a period of use, depending on the engine displacement, of 12,000 kilometers (7,456 miles), if the motorscooter's engine displacement is less than 170 cubic centimeters; of 18,000 kilometers (11,185 miles), if the motorscooter's engine displacement is equal to or greater than 170 cubic centimeters but less than 280 cubic centimeters; or of 30,000 kilometers (18,641 miles), if the motorscooter's engine displacement is 280 cubic centimeters or greater; or 5 (five) years from the date of initial retail delivery, whichever first occurs.

I **COVERAGE.** Warranty defects shall be remedied during customary business hours at any authorized Vespa Dealer or Authorized Piaggio/Vespa Service Center located within the United States of America in compliance with the Clean Air Act and applicable regulations of the United States Environmental Protection Agency and the California Air Resources Board. Any part or parts replaced under this warranty shall become the property of Piaggio.

- In the State of California only, emission related warranted parts are specifically defined by the state's Emission Warranty Parts List. These warranted parts are: carburetor and internal parts; intake manifold; fuel tank; fuel injection system; spark advance mechanism; crankcase breather; air cutoff valves; fuel tank cap for evaporative emission controlled vehicles; oil filler cap; pressure control valve; fuel/vapor separator; canister; igniters; breaker governors; ignition coils; ignition wires; ignition points; condensers, and spark plugs if failure occurs prior to the first scheduled replacement; and hoses, clamps, fittings and tubing used directly in these parts. Since emission related parts may vary from model to model, certain models

may not contain all of these parts and certain models may contain functionally equivalent parts.

- In the State of California only, Emission Control System emergency repairs, as provided for in the California Administrative Code, may be performed by other than an authorized Vespa Dealer or Authorized Piaggio/Vespa Service Center. An emergency situation occurs when an authorized Vespa Dealer is not reasonably available, a part is not available within 30 days, or a repair is not complete within 30 days. Any replacement part can be used in an emergency part can be used in an emergency repair. Piaggio will reimburse the owner for the expenses, including diagnosis, not to exceed Piaggio's suggested retail price for all warranted parts replaced and

labor charges based on Piaggio's recommended time allowance for the warranty repair and the geographically appropriate hourly labor rate. The owner may be required to keep receipts and failed parts in order to receive compensation.

## II LIMITATIONS

This Emission Control System warranty shall not cover any of the following:

- A) Repair or replacement required as a result of
  - (1) accident,
  - (2) misuse,
  - (3) repairs improperly performed or replacements improperly installed,
  - (4) use of replacement parts or accessories not conforming to Piaggio specifications which adversely affect performance and/or,
  - (5) use in competitive racing or related events.
- B) Inspections, replacement of parts and other services and adjustments required for required maintenance.

C) Any motorscooter on which the odometer mileage has been changed so that actual mileage cannot be readily determined.

## III LIMITED LIABILITY

A) The liability of Piaggio under this Emission Control System Warranty is limited solely to the remedying of defects in material or workmanship by an authorized Vespa Dealer at its place of business during customary business hours. This warranty does not cover inconvenience or loss of use of the motorscooter or transportation of the motorscooter to or from the Vespa Dealer. PIAGGIO SHALL NOT BE LIABLE FOR ANY OTHER EXPENSES, LOSS OR DAMAGE, WHETHER DIRECT, INCIDENTAL, CONSE-

QUENTIAL OR EXEMPLARY ARISING IN CONNECTION WITH THE SALE OR USE OF OR INABILITY TO USE THE VESPA MOTORSCOOTER FOR ANY PURPOSE. SOME STATES DO NOT ALLOW THE EXCLUSION OR LIMITATION OF ANY INCIDENTAL OR CONSEQUENTIAL DAMAGES, SO THE ABOVE LIMITATIONS MAY NOT APPLY TO YOU.

B) NO EXPRESS EMISSION CONTROL SYSTEM WARRANTY IS GIVEN BY PIAGGIO EXCEPT AS SPECIFICALLY SET FORTH HEREIN. ANY EMISSION CONTROL SYSTEM WARRANTY IMPLIED BY LAW, INCLUDING ANY WARRANTY OF MERCHANTABILITY OR FITNESS FOR A PARTICULAR PURPOSE, IS LIMITED TO THE EXPRESS EMISSION CONTROL SYSTEM WARRANTY TERMS STATED IN THIS WARRANTY. THE FOREGOING STATEMENTS OF WARRANTY ARE EXCLUSIVE AND IN LIEU OF ALL OTHER REMEDIES. SOME STATES DO NOT ALLOW LIMITATIONS ON HOW LONG AN IMPLIED WARRANTY LASTS SO THE ABOVE LIMITATIONS MAY NOT APPLY TO YOU.

C) No dealer is authorized to modify this Piaggio Limited Emission Control System Warranty.

#### IV LEGAL RIGHTS

THIS WARRANTY GIVES YOU SPECIFIC LEGAL RIGHTS, AND YOU MAY ALSO HAVE OTHER RIGHTS WHICH VARY FROM STATE TO STATE.

V THIS WARRANTY IS IN ADDITION TO THE PIAGGIO LIMITED MOTORSCOOTER WARRANTY.

#### VI ADDITIONAL INFORMATION

Any replacement part that is equivalent in performance and durability may be used in the performance of any maintenance or repairs. However, Piaggio is not liable for these parts. The owner is responsible for the performance of all required maintenance. Such maintenance may be performed at a service establishment or by any individual. The warranty period begins on the date the motorscooter is delivered to the ultimate purchaser.

Manufacturer: Piaggio & C. SpA  
Viale Rinaldo Piaggio, 25  
58025 Pontedera (PISA)  
Italy

Importer: Piaggio USA, Inc.  
20003 South Rancho Way,  
Rancho Dominguez, CA90220  
USA  
Phone Number: 1-866-474-2444

## INDEX

<b>1 VESPA</b>	
INSTRUMENT PANEL .....	1.1
CONTROLS AND DIGITAL CLOCK .....	1.2
THE PIAGGIO IMMOBILIZER SYSTEM .....	1.3
IDENTIFICATION .....	1.4
<b>2 OPERATION</b>	
CHECKS AND SUPPLIES .....	2.1
RUNNING IN .....	2.2
SHOCK ABSORBER - OPENING THE HELMET COMPARTMENT .....	2.3
STARTING THE ENGINE .....	2.4
RIDER SAFETY .....	2.5
BASIC SAFETY RULES .....	2.6
<b>3 MAINTENANCE</b>	
ENGINE OIL LEVEL .....	3.1
REAR HUB OIL LEVEL .....	3.2
TIRES .....	3.3
REMOVING THE SPARK PLUG AND AIR FILTER .....	3.4
BRAKE FLUID LEVEL .....	3.5
ELECTRICS .....	3.6
BATTERY AND FUSES .....	3.7

## INDEX

<b>4 WHAT TO DO IF ...</b>	
... A BULB BURNS OUT .....	4.1
... THE HEADLIGHT REQUIRES ADJUSTMENT .....	4.2
... THE REAR-VIEW MIRRORS REQUIRE ADJUSTMENT .....	4.3
... IDLE SPEED REQUIRES ADJUSTMENT .....	4.4
... FRONT BRAKE REQUIRES ADJUSTMENT .....	4.5
... REAR BRAKE REQUIRES ADJUSTMENT .....	4.6
... YOU NEED TO STORE THE VEHICLE .....	4.7
... THE VEHICLE NEEDS CLEANING .....	4.8
... YOU NEED TO PINPOINT A FAULT .....	4.9
<b>5 SPECIFICATIONS</b>	
SPECIFICATIONS AND PERFORMANCE DATA .....	5.1
<b>6 SPARE PARTS AND ACCESSORIES</b>	
SPARE PARTS .....	6.1
ACCESSORIES .....	6.2
<b>7 SCHEDULED MAINTENANCE</b>	
SERVICE CHECKSHEETS .....	7.1
RECOMMENDED PRODUCTS .....	7.2

# 1 VESPA

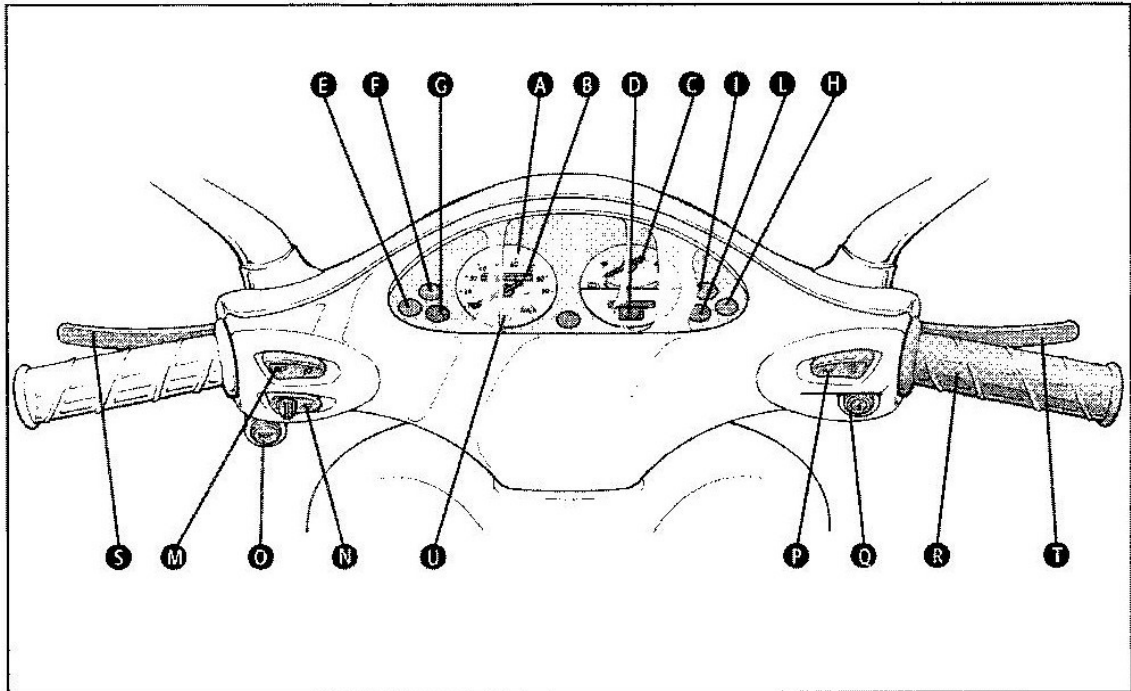

26

## INSTRUMENT PANEL 1.1

- A** = Speedometer
- B** = Odometer
- C** = Fuel gauge
- D** = Clock/Calendar
- E** = Left turn indicator
- F** = Oil pressure warning light
- G** = High beam indicator
- H** = Right turn indicator
- I** = Fuel warning light
- L** = Light indicator
- M** = Headlight high beam/dipped beam selector
- N** = Turn signal selector
- O** = Horn
- P** = Engine Stop switch
- Q** = Starter button
- R** = Throttle
- S** = Rear brake lever
- T** = Front brake lever
- U** = Immobilizer system connection / diagnostic LED output

27

# 1 VESPA

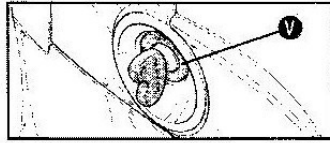

Fig. 1

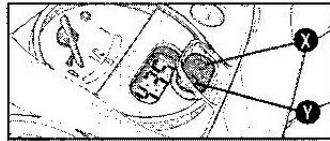

Fig. 2

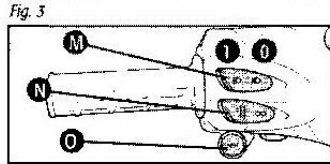

Fig. 3

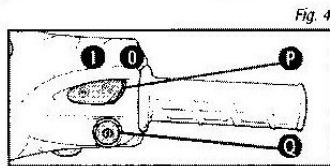

Fig. 4

## KEY SWITCH «V»

**LOCK** = Ignition OFF, key can be removed, steering locked, front glove box locked.

**OFF** = Ignition OFF, key can be removed, steering unlocked, front glove box unlocked.

**ON** = Ready to start engine, immobilizer disarmed, key cannot be extracted, glove box unlocked.

## LOCKING THE STEERING:

turn the handlebars completely to the left and then turn the key to the «**LOCK**» position (see fig. 1) and remove it.

## UNLOCKING THE STEERING:

insert the key and turn it to the «**OFF**» position.

## OPENING THE GLOVE BOX:

turn the key to the «**OFF**» position and then press it.

When the key is in the «**LOCK**» position the glove box is locked.

## ⚠ WARNING

Do not turn the key to the «**LOCK**» position while riding. This will inevitably lead to an upset, with subsequent serious accident, and serious injury or even death. Leave the key in the «**ON**» position while riding. Do not attempt to turn it until the scooter has stopped.

## CONTROLS AND DIGITAL CLOCK 1.2

### TURN SIGNAL SELECTOR «N»

To activate the left hand turn indicators, press the selector to the left, for the right hand turn indicators press it to the right. The selector automatically returns to the centre position when released and the turn indicators remain activated. To switch off the indicators, press the selector in.

### ENGINE STOP SWITCH «P»

**0** = Engine run  
**1** = Engine off

### DIP/FULL BEAM SELECTOR «M»

**0** = Dipped beam  
**1** = High beam

### HORN BUTTON «O»

### STARTER BUTTON «Q»

### DIGITAL CLOCK

Positioned on the instrument panel (see fig. 2), displays hours and minutes from 1 to 12, A (a.m.) or P (p.m.). By pressing «**X**» the clock can display month, day and seconds. Use button «**Y**» to set the various clock functions. The digital clock runs from a small dry cell battery (which lasts about 2 years) accessible by lifting the entire instrument panel. We recommend to contact an **Authorized Piaggio/Vespa Service Center** to change the clock battery.

♻ Used batteries are harmful for the environment. Take used batteries to your nearest collection point for disposal as prescribed by law.

# 1 VESPA

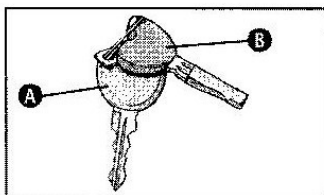

Fig. 1

Fig. 2

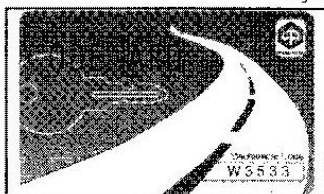
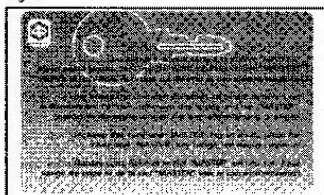

Fig. 3



To increase the safety of your new vehicle against the risk of theft, we have installed an electronic engine immobilizer which is armed when the ignition key is extracted. When you insert the key to start the engine, the «**PIAGGIO IMMOBILIZER**» system checks the key code and only allows the engine to be started when the code has been accepted.

## KEYS

Two different types of keys are supplied with the motorscooter (see fig. 1).

## NOTE

If you lose the red key, it will be impossible to carry out repairs to the «**PIAGGIO IMMOBILIZER**» system and the engine control unit.

Key «**A**» with the red plastic grip is the «**MASTER**» key. Only one master key is supplied with the motorscooter. This key is used to store the code of the other keys or for Dealer/Service Center interventions. Keep the master key safely and only use it when absolutely necessary.

Key «**B**» (single copy supplied) with the blue plastic grip is the regular motorscooter key and is used for:

- start-up
- unlocking the helmet compartment
- unlocking the glove box

Together with the keys, you should have a **CODE CARD** (figures 2 and 3) showing the key code.

## NOTE

Keep the **CODE CARD** and the red key in a safe place (do not keep them on your motorscooter).

30

## THE PIAGGIO IMMOBILIZER SYSTEM 1.3

### IMMOBILIZER SYSTEM CONNECTION LED OUTPUT

Operation of the «**PIAGGIO IMMOBILIZER**» system is signalled by the «**U**» warning light, see page 26.

To prevent the battery from running down, the LED turns off automatically after 48 hours of continuous flashing. If the system fails, the indicator LED flashes a code, which allows an **Authorized Piaggio/Vespa Service Center** to immediately identify the cause of the problem.

### OPERATION

Whenever you remove the ignition key when in the **OFF** or **LOCK** positions, your motorscooter is protected by the immobilizer system.

When you turn the key to **ON** the engine immobilizer is disarmed only if the protection system recognizes the code transmitted by the key.

If the engine does not start when you press the starter pushbutton, turn the key back to **OFF** and then to **ON** again; if the engine still fails to start, use the red key.

If you are still unable to start the engine, seek assistance from an **Authorized Piaggio/Vespa Service Center** who have the necessary electronic equipment to find the cause of the problem and remedy it.

### NOTE

If it is necessary to start the engine with a partially or completely discharged battery, or when the battery is not installed, the Piaggio immobilizer system allows for engine starting. Swiftly depress the kick-starter with the key turned on.

### **WARNING**

To avoid injuries to the lower part of the leg when operating the kick-starter make sure that non-slip shoes are worn and avoid high heels. Place the vehicle on the center stand. For detailed instruction on how operating with kick-starter see page 42.

31



# 1 VESPA

## NOTE

Each key has a unique code which must be stored by the immobilizer system control unit.

When ordering extra keys remember that the code storage procedure must be carried out for all keys (max. 7), i.e. the new ones and the ones you have already received.

## NOTE

Protect the keys from impacts - risk of damaging the electronic components inside the grip.

If necessary, seek assistance from an **Authorized Piaggio/Vespa Service Center**, taking with you the red key plus the blue keys as well.

The codes of all keys that are not entered during the code storage procedure will be erased from the memory. This means that lost or stolen keys can be easily rendered inoperative.



## CAUTION

If the vehicle is sold, the new owner must be provided with the red master key (and the other keys) and the "CODE CARD".

## THE PIAGGIO IMMOBILIZER SYSTEM 1.3

### PROGRAMMING THE IMMOBILIZER SYSTEM

These following instructions cover the procedure for programming the **PIAGGIO IMMOBILIZER** system and/or storing additional keys in the memory.

#### STEP ONE - RED KEY

Insert the red key into the key switch (on **OFF** position) and turn it clockwise to **ON**. Leave the key in this position for between 1 and 3 seconds and then turn it back to **OFF** and remove it.

#### STEP TWO - BLUE KEY

Insert the blue key within 10 seconds of having extracted the red key and immediately turn it to **ON**. Leave the key in this position for between 1 and 3 seconds and then turn it back to **OFF** and remove it.

You can repeat this step for up to 7 blue keys.

#### STEP THREE - RED KEY

After removing the last blue key insert the red key again and turn it to **ON** (no more than 10 seconds after you extracted the blue key). Keep it in this position for between 1 and 3 seconds and then turn back to **OFF**.

#### STEP FOUR - CHECKING

Insert the red key and flip open the hinged section of the key grip (this prevents the key from transmitting the code information to the immobilizer system). Now turn the key to **ON** and press the starter button. The engine should not start. Insert one of the programmed blue keys and repeat the engine start procedure. The engine should now start.

## NOTE

If the engine starts with the red key (when the hinged section of the grip is open) or if you have made any mistakes during key programming, repeat the entire procedure from the beginning.

## NOTE

The use of non-original spark plugs or an unshielded plug cap can cause interference with the system.

## 1 VESPA

## IDENTIFICATION 1.1

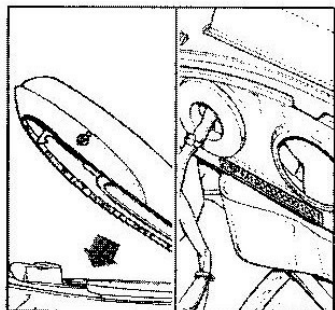

Fig. 1

### FRAME AND ENGINE

The serial numbers are made up of a code stamped into the frame (fig. 1) and the engine block (fig. 2). Always quote the serial numbers when ordering spare parts.

Check that the frame number on the vehicle is identical to the number shown in the owner's handbook.

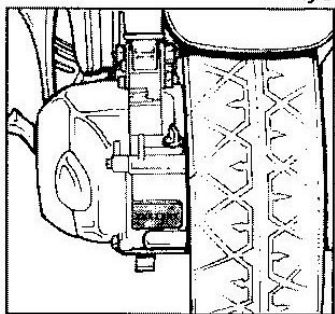

Fig. 2

Defacing factory serial numbers is a serious criminal offense and can lead to confiscation of the vehicle or other penalties.

### CAUTION

In all states and countries, it is against the law to alter the Vehicle Identification Number (VIN) and can result in severe penalties. This will immediately invalidate your warranty.

## 2 OPERATION

## CHECKS AND SUPPLIES 2.1

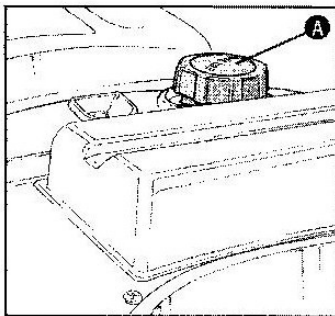

Fig. 1

### BEFORE USING YOUR MOTORSCOOTER CHECK:

1. Full fuel tank.
2. Gearbox oil level.
3. Sump oil level (page 54).
4. Tires correctly inflated.
5. Lights and turn indicators working properly.
6. Front and rear brakes working properly.

### TIRE PRESSURE

Front wheel: 1.3 bar (18.9 psi)  
Rear wheel: 1.8 bar (26.1 psi)

### (DRIVER PLUS PASSENGER)

Front wheel: 1.6 bar (23.2 psi)  
Rear wheel: 2.0 bar (29 psi)

### NOTE

Check inflation pressure with tires cold.

### REFUELLING

Fill fuel tank «A» (fig. 1) with unleaded gasoline. Minimum octane rating (M+R)/2 method 90.

### WARNING

Before refuelling, stop the engine. Gasoline is highly flammable. Keep it away from hot engine parts. Failure to heed this warning can lead to a serious fire.

### WARNING

Fire hazard: keep open flames, lighted cigarettes etc. well clear of the fuel tank filler opening. Gasoline vapor is harmful if inhaled. Keep your face clear of the fuel tank filler opening.

### WARNING

Use only the recommended types of oil. See page 92. Use of inferior oil will lead to reduced engine life, and can lead to an engine seizure, with subsequent upset, serious accident, and serious injury, or even death.

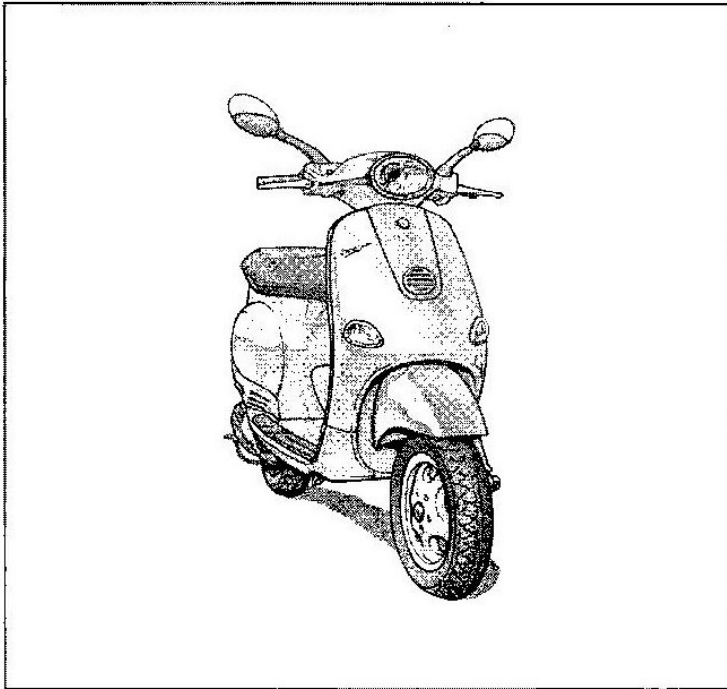

During the first 625 miles (1,000 km) keep to within 80% of full throttle opening. Do not undertake long journeys at constant speed. After the first 625 miles (1,000 km) you can start increasing speed gradually up to the maximum (within the limits of the law and in accordance with road and traffic conditions).

36

## SHOCK ABSORBER - OPENING THE HELMET COMPARTMENT 2.3



Fig. 1

Fig. 2

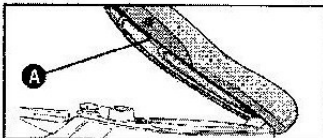
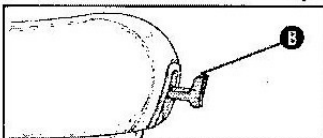

Fig. 3



Fig. 4



### REAR SHOCK ABSORBER MANUAL LOAD ADJUSTMENT

Depending on the load and the type of ride desired, the shock absorber can be adjusted to four positions using the supplied spanner to turn the ring nut on the bottom of the unit as shown in fig. 1.

Recommended settings:

Position 1: }  
Position 2: } RIDER ONLY

Position 3: }  
Position 4: } RIDER AND PASSENGER

### TIPPING UP THE SADDLE TO ACCESS THE HELMET COMPARTMENT AND FUEL FILLER CAP

Insert the key in lock «A» and turn it counter-clockwise (fig. 2). Tip the saddle forwards.

### HELMET STORAGE

Place the helmet in the compartment as shown in the figure 3.

### BAG CLIP

To use the bag clip «B» (figure 4) extract it by pulling it towards the handlebars.

37

## 2 OPERATION

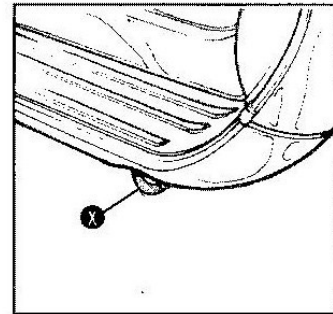
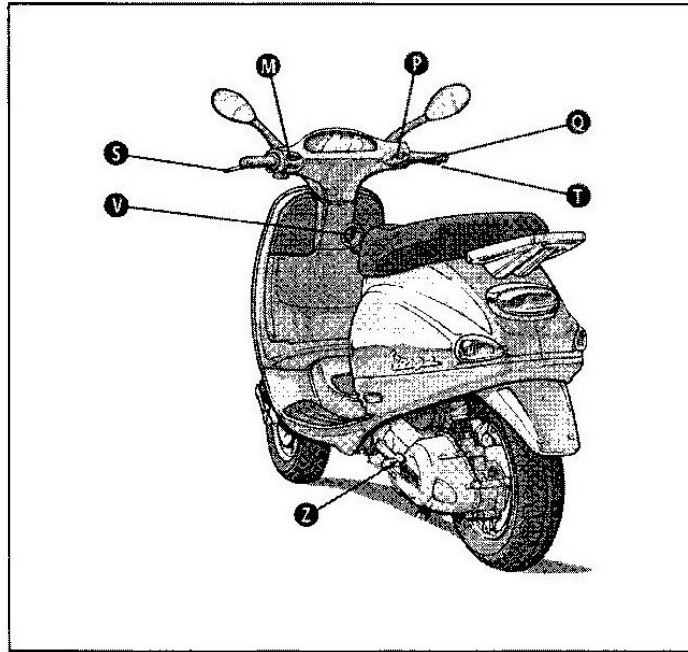

38

### STARTING THE ENGINE 2.4

Your Vespa is equipped with an automatic transmission system with centrifugal clutch. Always start the engine with the throttle rotated fully clockwise; that is, at idle position. Gradually accelerate to pull away.

With reference to the figure on page 38 carry out the operations herebelow described. Please note that this motorscooter has a fuel line tap and a choke which are automatically controlled when the starter button is pressed.

#### STARTING THE ENGINE

- A:** Place the vehicle on center stand and check that the rear tire is not touching the ground.
- B:** Keep the throttle closed.
- C:** Move the engine stop switch «P» to the "O" (ON) position.
- D:** Insert the ignition key and turn it to "ON".

**E:** Pull rear brake lever «S» or front brake lever «T» and then press starter button «Q».

**F:** If the battery is discharged, or if the motorscooter electrical system is not working properly, use the kickstarter «Z».

#### STOPPING THE ENGINE

When the vehicle is stopped with the engine idling turn the ignition key «V» to "OFF" (key can now be extracted). Use the center stand to support the motorscooter while parked.

Park the motorscooter on firm, level ground to prevent it from falling. Lock the steering to help prevent theft.

#### ANTITHEFT

The ring «X» located on the right hand side of the motorscooter is to be used only to chain your motorscooter to a fixed object. Do not use it for any other purpose.

#### WARNING

Never attempt to start your engine with the throttle in the open position. This can lead to runaway, with upset, and subsequent serious injury, or even death.

#### WARNING

Use the engine stop switch «P» only if the engine runs away. It is for emergency use only. Once the switch is activated, your motorscooter will slow very abruptly. Only in case of emergency the engine stop switch should be used while the motorscooter is running.

#### WARNING

Never attempt to place the ignition switch in the locked "+" (LOCK) position while the motorscooter is moving. This will cause loss of control of the motorscooter with possible subsequent accident, serious injury or even death.

39

## 2 OPERATION

### **WARNING**

Do not place anything inside the front part of the fairing between the handlebar and the dashboard. Any object placed in this area could jam the forks, and also could restrict visibility of the dashboard.

### **WARNING**

Never take your hands off the hand grips nor your feet off the foot rests while you are riding. Failure to do this could upset the stability of the vehicle. Before riding away, make sure that the stand is completely up. Failure to follow these warnings may cause an accident with consequent risk of serious injury or even death.

To ride away:

- Allow the throttle to return to idle, apply the rear brake, then remove the vehicle from the stand.
- Get on the vehicle, keeping at least one foot on the ground in order not to lose balance.
- Before driving, be sure that the rear view mirrors are correctly adjusted.

### **CAUTION**

When the vehicle is new to you, practice looking in the rear view mirrors. Only experience will allow you to correctly determine the exact location of other vehicles and objects behind you.

- To begin, release the brake lever and accelerate by gently rotating the throttle grip; the vehicle will start moving.

- Ride at reduced speed for the first few miles in order to warm up the engine.

### **CAUTION**

Never ride away abruptly with a cold engine.

To reduce the emission of polluting substances and the consumption of fuel, warm up the engine by proceeding at low speed for the first few miles.

### **WARNING**

When braking, close the throttle and apply both brakes simultaneously in order to obtain the best brake performance.

By applying only the front brake or only the rear brake, you reduce the braking efficiency considerably, and run the risk of locking up one wheel. This can cause an upset and subsequent serious injury or even death.

## STARTING THE ENGINE 2.4

Do not attempt to maintain your position on a hill by running the engine. This will very quickly destroy the transmission, and overheat the engine.

Before entering a turn, slow the motorscooter using the brakes, to a constant speed and then accelerate slightly through the turn. Avoid braking at the last moment. This can cause you to lose control of your vehicle.

If the brakes are operated continuously on downhill grades, the discs and pads will overheat, reducing the braking efficiency. Use the brakes as little as possible to maintain a safe speed. Never coast downhill with the engine off.

### **WARNING**

On roads that are wet or covered with snow, ice or mud, ride very slowly, avoiding braking or accelerating or maneuvering quickly. Hold the handlebar firmly.

Failure to heed these warnings can cause an upset with subsequent serious injury or death.

Pay very close attention to any obstacles or variations of the road surface. Uneven roads, rails, manhole covers, painted traffic stripes, traffic dots all become slippery when wet. Avoid particularly steel plates which are sometimes used during road maintenance. They become more slippery than ice once they are wet by rain. If you must ride on such surfaces,

decrease your speed and operate the throttle, brakes and steering very gently.

Always use the turn signals any time you intend to change lanes or change direction, and avoid sudden or abrupt turning.

Switch off the direction indicators as soon as you have changed direction.

Overtake and pass with care, especially in rainy weather. A water cloud created by larger vehicles will reduce visibility and the slip stream could cause you to lose control of your vehicle.

## 2 OPERATION

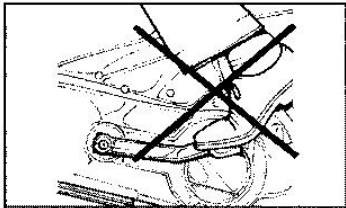

Fig. 1

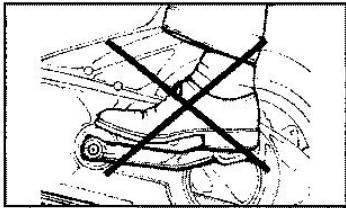

Fig. 2

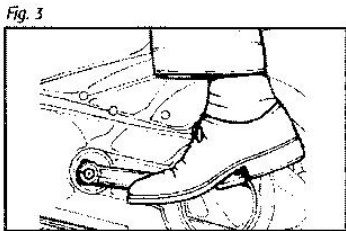

Fig. 3

### **WARNING**

Exhaust fumes are noxious: do not start the engine in an enclosed place.

Possible causes for engine starting difficulties and suggested action:

#### 1. **Carburetor flooded.**

Go through the steps described below. Open the throttle fully and press starter button «Q» five or six times. Do not keep the button pressed for more than 5 seconds at a time.

#### 2. **Battery flat (except vehicles provided with the immobilizer system) or starter motor faulty.**

Put the motorscooter on its stand and make sure the rear tire is not touching the ground. Bring the ignition key «V» to the "ON" position and use kick-starter «Z».

### **WARNING**

If using the kick-starter is necessary please read the following instructions in order to avoid injuries:

- Use the kick-starter only with sturdy footwear (i.e. low heel, rubber sole).
  - Place the vehicle on the center stand.
  - Move to the left side of the vehicle.
  - Move the engine stop switch «P» to the "O" (ON) position.
  - Make sure the dimmer switch «M» is in the low beam "D" position.
  - Rotate the ignition key «V» to the "O" (ON) position.
- To avoid losing control of your vehicle while you start it:
- firmly hold the rear rackpack with your right hand.

42

## STARTING THE ENGINE 2.4

- place your right foot on the kick-starter (see fig. 3) and push down slowly until you feel that the kick-starter is properly engaged. The kick-starter is properly engaged when the lever is in the highest position and offers the strongest resistance.
- when the kick-starter is properly engaged, push the lever down swiftly to start the vehicle.
- if necessary, repeat operation until the engine starts.

### **CAUTION**

Do not depress the kick-starter while the engine is running.

#### 3. **Fuel tank empty.**

Refuel. Start the engine, pressing the starter button «Q» while keeping the throttle closed to generate maximum suction on the fuel line.

#### 4. **Engine too hot.**

Follow the standard engine start procedure above, but keep the throttle slightly open.

If you are still unable to start the engine, we recommend to contact an **Authorized Piaggio/Vespa Service Center**.

### **WARNING**

Always put the vehicle on its stand before kick-starting.

Failure to observe this warning can lead to serious personal injury, as well as damage to your motorscooter. Your scooter is equipped with a newly designed starting system, which is connected to an automatic valve lifter, which reduces wear and tear on the electric starter, as well as reducing the force that must be applied to the kick-starter.

If the ambient air temperature is -10°C (50°F) or below, a special cold starting procedure must be followed:

1. turn on the ignition.
2. turn the engine over several times, by depressing the kick-starter.
3. Wait for about 2 minutes, to allow the carburetor electric heater to warm up the carburetor.
4. Start the engine in the normal manner.

43

## 2 OPERATION

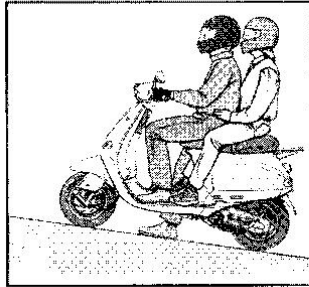

Fig. 1

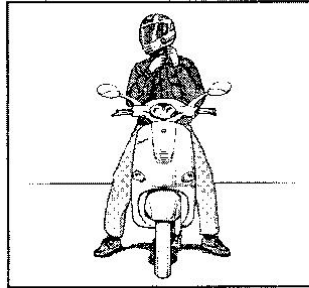

Fig. 2

### AUTOMATIC TRANSMISSION

For easy and comfortable riding, your new vehicle has an automatic transmission with a centrifugal clutch. This system is designed to provide optimal fuel consumption and acceleration by adjusting the transmission ratio in relation to torque demands and engine speed. If you need to stop on a hill gradient (traffic lights, tailbacks etc.) restrain the vehicle with the brakes alone (engine should be idling). Using the engine to hold the vehicle can cause the clutch to overheat. Overheating is caused by prolonged slipping of the centrifugal clutch. Apart from the example above, the clutch will tend to slip when tackling very steep gradients with a heavily laden vehicle or when starting up on gradients greater than 25%.

1. Limit the duration of extreme conditions such as the above
2. Allow the engine to idle for a few minutes to give the clutch time to cool.

### **WARNING**

Failure to follow these simple recommendations can damage your motorscooter, and lead to an accident, with subsequent serious injury, or even death. The life of your motorscooter, and your enjoyment of it, will be greatly enhanced if you avoid situations in which the motorscooter will be abused by attempting to carry too heavy a load, or starting on too steep a hill.

## RIDER SAFETY 2.5

Your riding skill and a through knowledge of your motorscooter are the basic ingredients of road safety. Practice riding your motorscooter in a traffic-free area until you are fully in control under various different conditions.

### **WARNING**

Never ride under the influence of alcohol or drugs as this is dangerous for yourself and others.

### **BE SURE TO RIDE SAFELY, DEFENSIVELY AND WITHIN THE LIMITS OF THE LAW AND YOUR ABILITIES**

- Before starting, put on an approved helmet and secure the straps correctly.
- Reduce speed on unsurfaced roads or uneven ground and exercise maximum caution.
- Riding in the rain or on wet roads can cause the brakes of your motorscooter to become wet. When this happens, their effectiveness will be greatly reduced. In these conditions, gently activate the brakes regularly, to dry the brakes, and so that you may check the braking action.
- Use extreme caution when braking on wet roads, unsurfaced roads or any other slippery surfaced.
- Always use both brakes simultaneously to distribute braking force over both wheels.
- Do not mount the motorscooter when it is on the stand. Before taking the motorscooter off the stand make sure the rear wheel is not spinning.
- When your motorscooter is used on sandy, muddy, salty, or snow-covered roads, periodically clean the brake disc with a gentle cleaning agent. This will avoid the build-up of abrasive materials in the slots in the disc, which will cause early and uneven brake pad wear.
- Do not modify your motorscooter in any way. This motorscooter is carefully engineered to provide optimum performance and safety. You will only reduce its utility and your enjoyment of the motorscooter by modifying it.

### **WARNING**

Over-braking on a slippery surface will lead to upset, an accident, and subsequent injury or possibly even death.

## 2 OPERATION

The instructions given below cover normal operation of your motorscooter and must be carefully observed.

By following these rules you will enhance your own safety and the safety of others. You will also maximize the life and utility of your motorscooter.

Motorscooters obviously do not provide some of the protection provided by automobiles, therefore it is essential that you wear appropriate protective clothing. Never operate your motorscooter without wearing a helmet, gloves, eye protection, a heavy jacket, sturdy footwear, and sturdy full length pants.

However, do not assume that even the best clothing and helmet will protect you in the event of an upset or a crash with another vehicle. At best, this gear provides some protection from scrapes and scratches, but very little, if any, impact protection.

Be sure that you meet all the require-

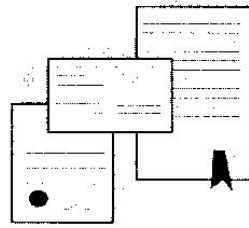

ments prescribed by local law, including driver's license, minimum age, training, insurance, taxes, motorcycle registration, license plate, etc.

When you first receive your motorscooter, practice by riding in areas where there is no traffic. Do not attempt to ride in heavy traffic until you are thoroughly experienced and riding your motorscooter has become second nature to you.

Most states prohibit the operation of this size motorscooter on freeways or express-ways. Be sure that it is legal to use your motorscooter before you



take any particular road.

A new motorscooter must be carefully broken in, see p. 36 (RUNNING-IN).

Before starting the engine, make sure that the brakes, transmission and throttle controls function properly and that the fuel and oil supply is adequate.

The exhaust system, brakes, and some other parts of the motorscooter become very hot during operation. Do not touch any of these parts.

Some medicines or drugs, illegal or prescription, and alcohol significantly increase the risk of accidents.

46

### BASIC SAFETY RULES 2.6

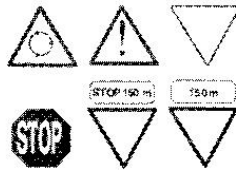

Do not ride while you are under the influence of alcohol or drugs, whether they are illegal or prescription. Make sure you are in good physical condition and not ill before riding your motorscooter. Do not ride your motorscooter when you are particularly tired. Alcohol, drugs and fatigue are leading causes of motorscooter accidents.

Many accidents are caused by the rider's inexperience and lack of training. Do not ride your motorscooter until you have received training from a recognized training organization such as the Motorcycle Safety Foundation.

Remember that riding a motorscooter, though easy and fun, is quite different from driving a car. Do not assume that you can operate your motorscooter safely just because you are a competent automobile driver.

Never lend your motorscooter to others unless you are sure that they are competent and properly licensed motorcycle operators.

If the throttle sticks open, it may cause a collision with another vehicle or an upset. If the throttle sticks, turn off the engine with the engine stop switch located on the right hand side of the handlebar.



Do not attempt to restart the engine until the throttle has been repaired and works perfectly. Failure to obey this warning can lead to a run away with serious injuries or even death.

#### **WARNING**

In case of emergency always use the engine stop switch located on the right hand side of the handlebar. Do not ride the motorscooter if the throttle does not automatically return to idle. Contact your local Vespa Dealer or Authorized Piaggio/Vespa Service Center who will provide for the necessary repairs.

47



## 2 OPERATION

It is very important to your safety that you give full attention to the riding task. Watch what you are doing, do not allow yourself to be distracted by other cars, people or things on the roadside, etc. Never smoke, eat, drink, read, etc. while riding your motorscooter.

If you must consult a map, pull over when it can be done safely.

Use only your motorscooter's specific fuels and lubricants indicated in the "LUBRICANT CHART" see p. 92; check the oil, fuel and coolant levels regularly.

If you and your motorscooter are involved in an accident, ensure that there has been no damage to the con-

trol levers, tubes, wires, braking system and other vital parts. If your motorscooter is involved in an accident, take it immediately to your local Vespa Dealer or Authorized Piaggio/Vespa Service Center who has the equipment and knowledge to check for damage which may compromise your safety.

Your Vespa Dealer is qualified to help you with any safety problems that you might have, but of course it is necessary for you to report any malfunctions to your mechanic in order for him to help you.

Do not use your motorscooter if it is damaged.

A damaged motorscooter may become unstable or present other problems which can increase the risk of accident, and therefore serious injury or even death.

Do not attempt to modify the position, angle or color of your license plate. Do not cover it with even a clear plastic covering.

Do not modify any of the safety equipment of your motorscooter, especially such safety related items as directional indicators, rear view mirrors, lights or horn.

Any modification to your motorscooter will invalidate the warranty.

Do not modify your engine in an attempt to increase the horsepower. This can result in irreparable damage to the engine, as well as degradation of the performance and handling of your motorscooter which could lead to an upset, and serious injury or even death.

Have your motorscooter repaired only with original parts, and use only original Piaggio accessories.

## BASIC SAFETY RULES 2.6

The use of aftermarket accessories and parts can seriously compromise the safety of your motorscooter as well as affect its performance, stability and serviceability. Any modification which affects performance or safety voids your warranty completely.

For the reasons stated above, tampering with the exhaust emission or noise control systems of your motorscooter can lead to large fines. Also, in some jurisdictions, helmets are required by law, and in all jurisdictions, you must maintain your motorscooter in current registration (license plate up-to-date). Also, many jurisdictions require a special motorcycle license, and you must not ride your motorscooter without having first obtained this license. This motorscooter was not designed to be equipped with a sidecar or to be used to tow trailers, motorcycles, motorscooters or bicycles.

Piaggio does not manufacture sidecars or trailers and therefore cannot predict the effects of such accessories on the maneuverability or stability of your motorscooter: it can only warn that such effects may be negative and that any damage to the motorscooter components caused by the use of such accessories will not be covered by the warranty.

Never race other motorscooters or motorcycles with your motorscooter. Brake with both the front and rear brakes.

The use of one brake only for sudden braking may cause the motorscooter to skid or make the rider lose control of the motorscooter itself.

Always ride at a safe speed and avoid unnecessary hard acceleration.

This also reduces fuel consumption

and increases the life of the motorscooter.

If you must ride your motorscooter in rainy weather, or on loose surfaces, remember that traction is greatly reduced. Under these conditions, all handling of the motorscooter must be done gradually and smoothly. Sudden acceleration, braking or turning may cause you to lose control of your motorscooter. When traction is reduced, accelerate gradually and when slowing down release throttle and use your motorscooter engine braking in so far as possible, instead of braking abruptly.

Avoid rapid, harsh application of the brakes.

## 2 OPERATION

Gradually open and close the throttle, to avoid spinning or skidding the rear wheel. On rough road surfaces, slow down and ride with particular care. Avoid wide open throttle accelerations, unless they are necessary for passing.

Remember that excessively aggressive cornering can cause your motorscooter's tires to lose traction, which can result in an upset and serious injury or even death.

Always observe posted and statutory speed limits, but do not assume that you can ride as fast as the speed limit allows under all road conditions. Slowing down a little can greatly increase your safety under all road conditions.

Do not ride your motorscooter off road.

Do not tamper with the muffler system or the emissions control system of your motorscooter. This is not only bad for the environment, it can subject you to serious penalties.

### CLOTHING

Before riding your motorscooter, ensure that your riding gear is in good condition.

Your helmet must fit properly, and the visor or other eye protection must be clean.

Both research and experience have shown that drivers of other motorvehicles often do not see motorcycles riders. In order to make yourself more conspicuous to these drivers, wear bright reflective clothing, such as a reflective vest, or clothing with reflective sections sewn into the jacket, pants and gloves. Be particularly

aware of approaching automobiles and trucks that might be trying to turn left in front of you. Many motorcycle accidents are caused by an opposing automobile driver making a left turn without warning in front of the motorscooter.

Inevitably, the driver will look right at you, and yet swear that they did not see you before they turned directly into your path. Stay alert!

Wear protective clothing, preferably in light and/ or reflecting colors. In this way you will make yourself more visible to the other drivers, thus notably reducing the risk of being hit, and you will be more protected in case of such an incident.

Always wear your helmet. Many accidents are fatal because of injuries to the head.

## BASIC SAFETY RULES 2.6

An open-face helmet offers some protection, but a full-face helmet offers more. Regardless of the style, look for a DOT (Department of Transportation) sticker in any helmet you buy (USA only), and always wear a face shield or goggles to protect your eyes and help your vision.

### ADDITIONAL RIDING GEAR

In addition to a helmet and eye protection, we also recommend:

- Sturdy boots with non-slip soles to help protect your feet and ankles.
- Leather gloves to keep your hands warm and help prevent blisters, cuts, burns and bruises.
- A motorscooter riding suit or jacket for comfort as well as protection. Bright-colored and reflective clothing can help make you more noticeable in traffic. Be sure to avoid loose clothes that could get caught on any part of your motorscooter.

Clothing should be very tight-fitting and fastened at the wrists and ankles. Strings, belts and ties should not be hanging loose; prevent these and other objects from interfering with driving by getting entangled with moving parts or driving mechanisms.

Do not carry sharp objects in your pockets that could be dangerous in case of an upset. For example, pens or mechanical pencils, etc. Also, make sure that your passengers follow this recommendation.

## 2 OPERATION

### ACCESSORIES

The owner of the motorscooter is responsible for the choice, installation and use of any accessory.

The installation of inappropriate accessories or the overloading of the motorscooter may result in the instability of the motorscooter itself and cause accidents with consequent risk of serious injuries or even death. Windshields, in particular, can be dangerous, as they can break and injure the rider or passenger in case of an accident. If you have any doubt with regard to any accessory you would like to install, or any load you would like to carry, consult your local Vespa Dealer beforehand. Avoid installing accessories that cover horns or lights, or that could impair their functions. Don't install accessories that limit the suspension stroke or the steering angle, that interfere with the opera-

tions of the controls, or that reduce the motorscooter's lean angle in turns. Also, don't install accessories that could hamper your access to the various controls, since this could prolong reaction time during an emergency.

Fairings and windshields, or any other accessory that presents a considerable cross section, may produce aerodynamic forces that will affect the stability of the motorscooter, particularly at high speeds or in cross winds.

Make sure that anything carried on your motorscooter is securely attached, and cannot come loose and jam the wheels, forks, etc.

Do not install any electrical accessories, and do not modify the electrical system of your motorscooter. Anything that could cause an electrical overload or other fault could cause

the motorscooter to suddenly stop, the lights to dim or fail, or the horn and other safety accessories not to work. Use only Piaggio genuine accessories.

### LOAD

Do not overload your motorscooter. Attach luggage or packages as closely as possible to the center of your motorscooter and distribute the load from side to side as evenly as possible, to keep imbalance to a minimum. Remember that loads tend to loosen with riding, so frequently check the security of your load.

Do not hang anything from your motorscooter handlebar, fenders, or forks, because this will upset the handling of your motorscooter, and could prevent you from avoiding an accident.

### BASIC SAFETY RULES 2.6

Failure to heed this warning can lead to an upset with subsequent serious injury or even death. Do not ride with your crash helmet hung from the strap because it could easily become entangled with the wheels, fenders, or forks, causing an upset and subsequent serious injury or even death. When carrying a passenger, remember that your motorscooter's handling is degraded, that the brakes are less efficient, and the center of gravity is higher and further to the rear.

This makes it more likely that the front wheel will come up off the ground, especially on acceleration. Therefore, you should avoid hard acceleration and hard braking. Many accidents are caused by inexperienced riders carrying passengers.

Remember that allowance must be made for the extra weight of the pas-

senger for all driving maneuvers.

Avoid abrupt and excessive acceleration.

Always slow down in time and calculate longer stopping and maneuvering distances. Non-compliance with these instructions may lead to the overturning of the motorscooter or to other accidents with consequent serious injuries or even death. Never carry loosely packaged items and make sure that everything that you carry on your motorscooter is carefully secured.

Do not carry packages which protrude from the luggage rack or which cover any of the signal lights, the headlight, or the horn.

Children or animals must not be carried anywhere on your motorscooter.

Overloading your motorscooter seriously reduces its stability and maneuverability and can lead to an upset with subsequent serious injury or death.

## 3 MAINTENANCE

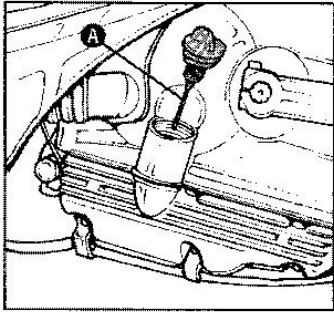

Fig. 1

### MAINTENANCE SAFETY

This section includes instructions on some important maintenance tasks. You can perform some of these tasks with the tools provided - if you have basic mechanical skills.

Other tasks that are more difficult and require special tools are best performed by professionals.

Removing the wheels should normally be handled only by a technician or other qualified mechanic; instructions are included in this manual only to assist in emergency service.

Some of the most important safety precautions follow. However, we cannot warn you of every conceivable hazard that can arise in performing maintenance. Only you can decide whether or not you should perform a given task.

### ENGINE OIL LEVEL

In your motorscooter's four-stroke engine the engine oil is used to lubricate the valve gear, the main bearings and the cylinder/piston assembly. **Insufficient lubrication can result in irreparable damage to the engine.**

Deterioration of the oil quality and slight oil consumption are perfectly normal in all four-stroke engines. Oil consumption will vary depending on the way the vehicle is used (e.g. high revving and high speed riding will result in increased oil consumption). The oil change intervals defined in the maintenance schedule are calculated on the basis of the total quantity of oil in the engine and average consumption values based on standardized parameters. **To prevent possible problems, always check the oil level before using the vehicle.**

**Also monitor the oil warning indicator on the instrument panel.**

### ENGINE OIL LEVEL 3.1

#### LEVEL CHECK

Every time you run the vehicle, check the oil with engine cold. Make sure the oil level is between the MAX and MIN marks on the dipstick, as shown in fig.1, and that the vehicle is resting on a flat surface during the level check. The MAX level mark shown in fig.1 indicates a quantity of oil of about a quart. (1000 cc).

If you check the oil with the engine hot, the level will be lower; to get a reliable reading you should wait for at least 10 minutes after stopping the engine.

#### TOPPING UP

Top up with oil after checking the level, if necessary. Make sure you **do not exceed the MAX level mark**. Check and top up with engine oil every 1875 miles (3,000 Km).

#### OIL PRESSURE WARNING LIGHT

The oil pressure warning light illuminates when the ignition key is turned to "ON" and should switch off when the motorscooter starts moving. Make sure the light switches off after the engine is started.

If the oil pressure warning light illuminates during braking, slow running, or in turns, check the oil level, and top up if necessary. If the problem persists, do not ride your motorscooter. Take it to your local Vespa Dealer or an Authorized Piaggio/Vespa Service Center before further riding.



#### OIL CHANGE CAUTION

Have your local Vespa Dealer change the engine oil every 3,750 miles (6,000 km). For oil changes and top-ups use new oil type **SELENIA HI SCOOTER 4Tech**.



#### CAUTION

Running the engine with insufficient or unsuitable oil causes rapid wear of moving parts and can result in irreparable damage.



Used oil is harmful for the environment. We recommend taking the motorcycle to an Authorized Piaggio/Vespa Service Center for oil changes. Our service centers are properly equipped for the disposal of used oil respecting the environment and is in compliance with the law.

## 3 MAINTENANCE

### **LUBRICANTS WARNING**

Proper vehicle lubrication is critical to safe operation.

Failure to maintain proper lubricant levels or to use the proper type of clean, new lubricant, can lead to an engine or transmission seizure with subsequent accident, serious injury or death.

### **WARNING**

Use latex gloves for the maintenance operations that require contact with used oil.

Used engine oil may cause skin cancer if repeatedly left in contact with the skin for prolonged periods. Although this is unlikely unless you handle used oil on a daily basis, it is advisable to thoroughly wash your hands with soap and water after han-

dling used oil.  
**KEEP OIL AWAY FROM CHILDREN.  
DISPOSE OF OIL PROPERLY.**

### **CAUTION**

Avoid spilling oil when putting it in your vehicle.

Clean up any oil spilled immediately as oil can damage the finish of your vehicle. Additionally, oil on the tires creates an extremely slippery, and therefore, dangerous situation.

### **CAUTION**

In case of oil leakage do not ride your vehicle. Before using the vehicle, have it repaired by your local Vespa Dealer or Piaggio/Vespa Authorized Service Center.

### **ENGINE OIL WARNING**

If the engine oil pressure warning light remains on (when the engine is running), or if it comes on during the normal running of the engine, this means that the oil system is not developing sufficient pressure. In this case, immediately stop the engine and contact your local Vespa Dealer or Authorized Piaggio/Vespa Service Center. Failure to heed this warning can lead to engine seizure, upset, and cause serious injury or even death.

### **CAUTION**

Perform these maintenance operations at one-half of the specified intervals, if your vehicle is used often in rainy or very dusty conditions, or on unpaved roads.

Check the engine oil level every 312 miles (500 km) see p. 54 (CHECKING THE ENGINE OIL LEVEL AND TOPPING UP).

56

## REAR HUB OIL LEVEL 3.2

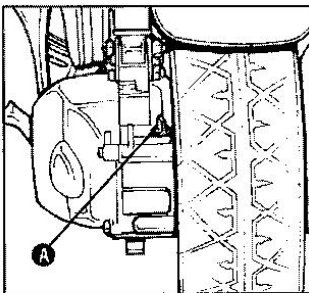
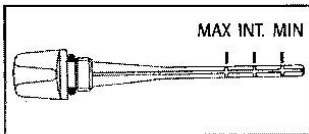

Fig. 1

Fig. 2



The rear hub oil content is 5 oz. with the motorscooter perfectly upright on its stand.  
The rear hub oil checking shall be performed as follows:

- 1) Place the vehicle on its stand on a level surface.
- 2) Unscrew the dipstick, dry it with a clean rag and then rescrew it completely.
- 3) Unscrew the dipstick and check that the oil level reaches the MIN notch.
- 4) Rescrew the dipstick completely.

Oil type:  
**TUTELA ZC90**

 Used oil is harmful for the environment. We recommend taking the scooter to an **Authorized Piaggio/Vespa Service Center** for oil changes. Our service centers are properly equipped for the disposal of used oil respecting the environment and in compliance with the law.

### **CAUTION**

Running the engine with insufficient or unsuitable oil causes rapid wear of moving parts and can result in irreparable damage.

It can also result in a seizure, which can lead to an upset, with subsequent serious accident, injury or even death.

57

## 3 MAINTENANCE

## REAR HUB OIL LEVEL 3.2/TIRES 3.3

### TRANSMISSION CAUTION

To check the oil level and to change the oil, contact your local Vespa Dealer.

Have your local Vespa Dealer check the transmission oil level as shown in the maintenance table (p. 91).

It is necessary to have your local Vespa Dealer change the transmission oil as shown in the maintenance table (p. 91).

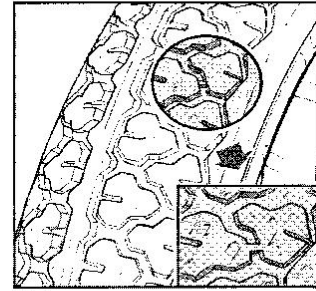

Fig. 1

**TIRE PRESSURE**  
**FRONT: 1.3 bar (18.9 psi)**  
**REAR: 1.8 bar (26.1 psi)**  
**with passenger**  
**FRONT: 1.6 bar (23.2 psi)**  
**REAR: 2.0 bar (29 psi)**

## 3 MAINTENANCE

## TIRES 3.3

Periodically check the inflation pressure of the front and rear tires.

The tires have tread indicators and must be replaced as soon as the indicators are visible on the tread (see Fig. 1). Check also for cuts on the tire walls and uneven tread wear. Piaggio recommends you have your tires changed by your local Vespa Dealer or by an Authorized Piaggio/Vespa Service Center.

### **TIRE REPAIR**

If a tire is punctured or damaged, you should replace it not repair it. As discussed below, a tire that is repaired, either temporarily or permanently, will have lower speed and performance limits than a new tire.

A temporary repair, such as an external tubeless tire plug, may not be safe for normal speeds and riding condi-

tions. If a temporary or emergency repair is made to a tire, you should ride slowly and cautiously to a Service Center and have the tire replaced.

If possible, you should not carry a passenger or cargo until a new tire is installed. Even when a tire is professionally repaired with a permanent internal patch plug, it will not be as good as a new tire.

In addition, you may not be able to safely carry as much weight as with a new tire. Therefore, we strongly recommend that you replace a damaged tire. If you choose to have a tire repaired, be sure the wheel is balanced before you ride.



### **WARNING**

Using tires that are excessively worn or improperly inflated can cause an accident in which you can be seriously hurt or killed. Follow all instructions

in this owner's manual regarding tire inflation and maintenance. Piaggio recommends you to always use original tires as replacement.



### **WARNING**

Incorrect tire inflation pressure causes uneven tread wear and will make your motorscooter unstable and potentially dangerous. You must never ride a motorscooter on a tire with a tread depth of less than 0.078" (2 mm). Do not use the motorscooter if the tire wear indicators show that the tire is worn out.

There are several kinds of treadwear indicators. For information on how to check the wear, see your Vespa Dealer. However, if the tires appear to you to be worn out, they certainly are, and should be changed.

## 3 MAINTENANCE

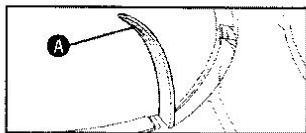

Fig. 1

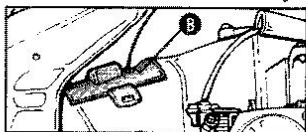

Fig. 2

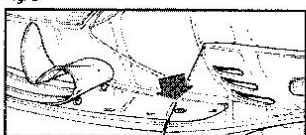

Fig. 5

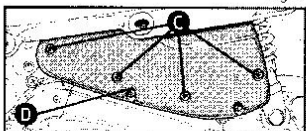

Fig. 4

### SPARK PLUG

Have the spark plug changed every 7500 miles (12000 km) at an **Authorized Piaggio/Vespa Service Center**.

To refit, the spark plug, follow above operations in the reverse order. Use the special spark plug wrench, tighten the spark plug firmly. Take great care not to cross thread or overtighten the spark plug.

Check the spark plug with engine cold following the procedure below:

1. Remove door «A» after loosening the screw;
2. Remove the helmet compartment;
3. Remove the spark plug cap;
4. Remove, by pulling it upwards, door «B» (fig. 2) on the engine casing;
5. Remove the spark plug with the supplied wrench (provided with stop rubber).

60

## REMOVING THE SPARK PLUG AND AIR FILTER 3.4

### CAUTION

The spark plug should be removed only when the engine is cold and wearing protective gloves.

The use of spark plugs with a heat range other than the prescribed type or with incorrect thread size can result in serious damage to the engine.

Refit the cover, taking care to engage the interlocking tabs in the lower part of the body panel, and secure with the screw.

### CAUTION

Danger of damage to "PIAGGIO Immobilizer" system; be sure to use the prescribed type of spark plug. The spark plug must be connected to the high tension (H.T.) lead by means of the shielded cap.

### AIR FILTER

Disassemble left hand lower side panel (fig. 3), unscrew the 4 fixing screws «C» (fig. 4) and the 2 knobs (accessible by tipping the saddle and removing the helmet compartment), remove air cleaner plug «D» and withdraw the filter element. Remove the filter, wash it in water and detergent, and dry it with compressed air. Treat the filter with a proprietary air filter oil (see par. 7.2). After you have applied the oil, squeeze the filter to eliminate excess oil, and leave it to dry before refitting it to your motorscooter.

61

### 3 MAINTENANCE

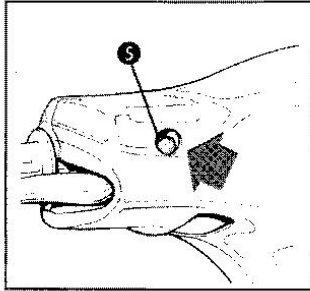

Fig. 1

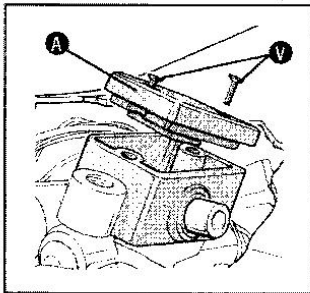

Fig. 2

The brake fluid reservoir is equipped with a sight glass «S» (located behind the aperture in the front right hand side of the handlebar fairing). The sight glass shows the level in the reservoir. With sight glass «S» completely covered with fluid, the level is above MIN. If the level drops, even slightly, the fluid level is considered MIN. If no fluid is visible through the sight glass, the fluid level is below MIN. The brake fluid level may fall due to wear of the brake pads.

**We recommend to bring the scooter to an Authorized Piaggio/Vespa Service Center for a general check-up of the brakes.**

If you need to top up the level, remove the handlebar fairing as described on page 70, unscrew the two screws «V» (fig. 2), remove the reservoir cap «A» and pour in the required quantity of fluid (the brake

fluid level must be above minimum). Check the level with the handlebars straight and the scooter perfectly level.

When refitting, make sure to properly tighten the two screws «V» of the brake fluid reservoir cap.

### BRAKE FLUID LEVEL 3.5



#### CAUTION

When topping up brake fluid use exclusively DOT 4 class products. Recommended brake fluid is **TUTELA TOP 4**.



#### CAUTION

Brake fluid is highly corrosive. If it comes into contact with painted parts of the motorscooter, wash off immediately with clean water.



#### CAUTION

In temperate climates, brake fluid should be changed every two years. Do not use fluid from previously opened or part-empty containers.



#### CAUTION

Brake fluid tends to absorb moisture from the air. If the brake fluid in the circuit contains excess moisture, braking efficiency will be impaired.

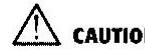

#### CAUTION

Always use synthetic brake fluid (identified by the marking  on the container). Mineral type brake fluid will damage the rubber seals on the brake circuit and must not be used on any account.



## 3 MAINTENANCE

### **BRAKES WARNING**

Do not ride your vehicle with worn or malfunctioning brakes! The brakes are the most important safety system of your vehicle. Using the motorscooter with brakes that are anything less than perfect is very likely to lead to a collision or upset, with consequent risk of serious injury or death.

Check the brake pad wear, as shown on p. 75 (CHECKING THE BRAKE PAD WEAR). Have your brakes serviced by your Local Vespa Dealer.

⊙ Check the brake shoe wear, as shown on p. 77. Have your brakes serviced by your local Vespa Dealer or Authorized Piaggio/Vespa Service Center.

### **WARNING**

Wet conditions seriously degrade the performance of your brakes. When the road is wet from rain, you should plan to use double the normal stopping distances since both the brakes themselves and the traction of the tires on the road are reduced by the presence of water.

Water on the brakes from washing your vehicle, or splashed up from wet roads, or crossing puddles or ditches, can wet the brakes sufficiently to greatly reduce their effectiveness. Whenever the brakes have become wet, always dry them by gently applying the brakes, repeatedly, until the heat causes the brakes to dry, and full brake function is restored.

Failure to follow this procedure can lead to loss of brake effectiveness and a serious accident.

### **NOTE**

This vehicle is equipped with front disc brakes and rear drum.

The following information may refer to just one braking system but should be observed with regard to both brakes.

### **WARNING**

The brakes are extremely important for your safety. Do not use the vehicle if the brakes do not work perfectly. Always check the brake efficiency before riding.

## BRAKE FLUID LEVEL 3.5

### **WARNING**

If the "feel" or position of the brake lever changes, this may be due to some problem in the hydraulic brake system. If you have any doubt regarding the perfect functioning of your brake system, or if the normal pre-ride checks indicate any discrepancy, contact your local Vespa Dealer or Authorized Piaggio/Vespa Service Center before riding.

### **WARNING**

Pay special attention to the brake disc and friction material, making sure that they are neither dirty nor oily, especially after maintenance operations or inspections.

Check the brake line, make sure that it is not twisted or crimped, nor leaking.

KEEP AWAY FROM CHILDREN.

DISPOSE OF USED BRAKE FLUID PROPERLY. SEE THE GENERAL WARNINGS ON PAGE 7 (BRAKE FLUID).

## 3 MAINTENANCE

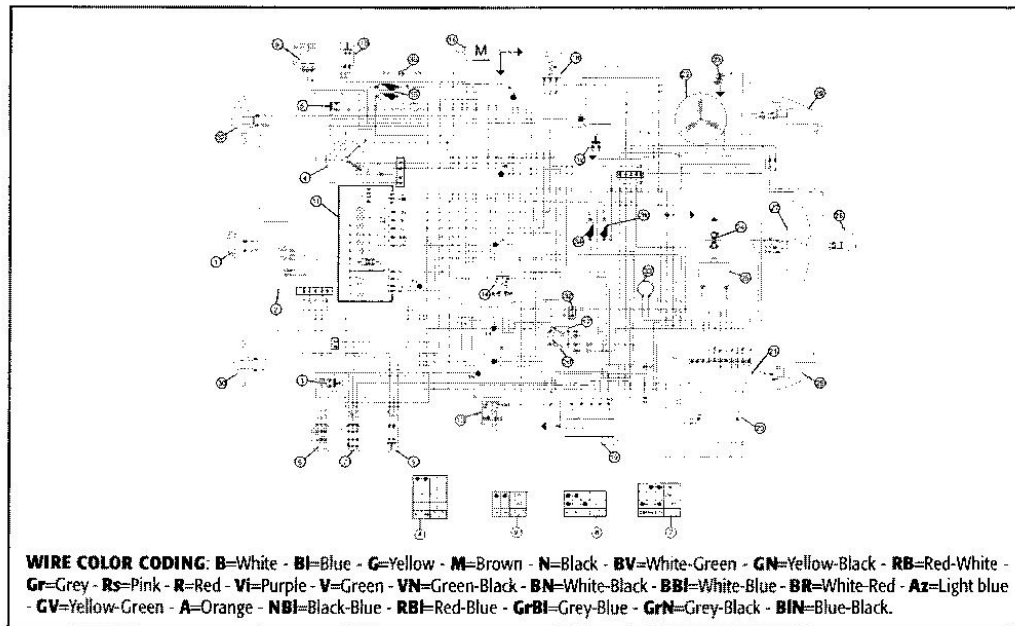

66

## ELECTRICS 3.6

The scooter is equipped with front and rear turn indicators and a starter motor. The starter motor, turn signals, brake light, front and rear running lights, registration plate light, the horn and headlight are powered by dc voltage (12V-10Ah battery).

### ⚠ CAUTION

When working on the electrical system, **pay special attention** to the correct connection of wires leading to the electronic ignition unit and observe the polarity and connector color coding.

### ⚠ CAUTION

Incorrect installation of electrical and electronic accessories can damage the vehicle.

### NOTE

Incorrect installation of music system and alarms can result in interference with the electronic control unit and the Piaggio immobilizer system. Any modification to the electric system will also invalidate your warranty.

### ELECTRICAL SYSTEM COMPONENTS

1. Horn.
2. Headlight with 1 lamp 12V-35/35W and one position light 12V - 5W.
3. Brake light/engine start enable button (rear brake).
4. Keyswitch.
5. Brake light/engine start enable button (front brake).
6. High/low beam selector.
7. Turn indicator selector.
8. Horn button.
9. Engine stop switch.
10. Starter button.
11. Instrument board, no. 5 bulbs 12V-1.2W and no. 4 bulbs 12V-2W.
12. Engine oil pressure sensor.
13. Engine stop.
14. Starter motor contactor.
15. Two 7.5 A fuses.
16. Fuel gauge transmitter.
17. Carburetor heater.
18. Starter motor.
19. Voltage regulator.
20. Battery 12V-10Ah.
21. Electronic ignition unit.
22. Magneto.
23. Pick-up.
24. Spark plug.
25. Separate HT coil.
26. Automatic choke.
27. Rear light unit with 12V - 5/21W bulbs (side light - brake light).
28. Registration plate light 12V - 5W.
29. Rear turn indicators with 12V/10W bulbs.
30. Front turn indicators with 12V/10W bulbs.
31. One 15 A fuse and one 7.5 A fuse.
32. Diagnostic LED output.
33. Immobilizer antenna.
34. Two 7.5 A fuses.
35. Diode

### ⚠ CAUTION

Modification or unsuitable repairs of the electrical system can cause malfunctions and represent a serious fire hazard.

67

## 3 MAINTENANCE

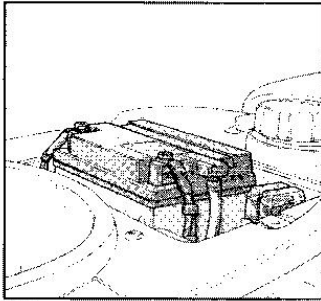

Fig. 1

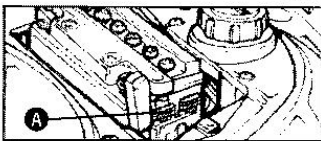

Fig. 2

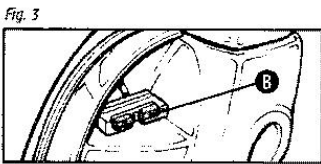

Fig. 3

### BATTERY

(Some motorscooters are equipped with maintenance free batteries. These procedures do not apply to such batteries).

To access the battery tip the saddle forwards and remove the battery compartment cover by unscrewing the phillips screws as shown in figure 1. The battery must be inspected and serviced regularly.

### STORAGE

If the motorscooter will not to be used for a long period, the battery must be charged periodically (when not in use, the battery will discharge over a period of about 3 months). If the battery is removed, re-install by making sure you connect the positive (red) (+) and negative (black) (-) leads to the correct terminals. Inverting battery polarity can damage electrical components.

### ELECTROLYTE LEVEL CHECK

Check regularly that the electrolyte is at maximum level. Top **only with distilled water**. If the battery needs topping too frequently, check the motorscooter electrics (the battery is probably working in overload conditions which will lead to rapid deterioration).

68

## BATTERY AND FUSES 3.7



**CAUTION**  
Never open the caps of maintenance-free batteries (containing gel): this could compromise the battery performance.



**CAUTION**  
Risk of damage to electrical system. Never disconnect the battery when the engine is running.

### FUSES

The electrical system is protected by two 15A fuses located next to the battery (see figure 2, detail «A») and by two 7.5 A fuses located on the left hand front side of the front case (see figure 3 part «B»).



**WARNING**  
Electrolyte contains sulphuric acid. Avoid contact with the skin, the eyes and clothing. In case of contact with the skin or the eyes rinse the affected area with plenty of water and consult a doctor. Do not lean the scooter over too far or electrolyte may spill from the battery. Keep open flames and sparks well away from the battery: explosion and fire hazard.



**CAUTION**  
Before replacing blown fuses, find and remedy the situation that caused the fuse to blow. Do not replace fuses with any alternative form of conductor.

 Batteries contain environmentally toxic substances. When you need to change the battery, we recommend to contact an **Authorized Piaggio/Vespa Service Center** to ensure your used battery is disposed of without harming the environment and in compliance with the law.

69

## 4 WHAT TO DO IF...

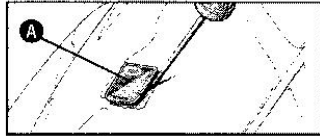

Fig. 1

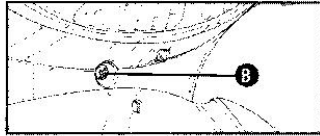

Fig. 2

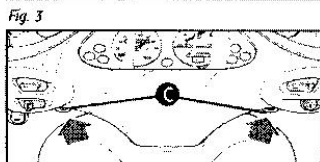

Fig. 3

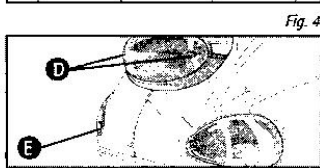

Fig. 4

### CHANGING THE HEADLIGHT BULBS

To access the headlight bulb (no. 1 bulb 12V-35/35W for high and low beam) and position lamp (no. 1 bulb 12V-5W) remove the front of the handlebar fairing as described below:

- 1) Remove the rear-view mirrors as described on page 73.
- 2) Remove the front grille panel by unscrewing screw «A» (fig. 1), after having removed the Piaggio shield (snap fitted) by means of a screwdriver. Be careful not to scratch paint finish.
- 3) Unscrew the three screws (one at the front «B», fig. 2 and two at the rear «C», fig. 3) that secure the handlebar fairing and then remove the fairing.

- 4) You will now be able to change the bulbs easily.

## ...A BULB BURNS OUT 4.1

### ⚠ CAUTION

Use a phillips screwdriver of the correct size. If you use alternative or makeshift tools you may damage the paintwork.

### CHANGING FRONT TURN INDICATOR BULBS

To change the front turn indicator bulbs, remove the rubber cover from inside the glove box and swivel the lamp-holder around in order to extract it.

### REPLACING THE REGISTRATION PLATE BULBS

Remove the bulb socket under the rear mudguard and then remove the bulb.

### CHANGING TAIL-LIGHT AND REAR TURN INDICATOR BULBS

To access the tail-light and turn indicator bulbs remove the 2 screws «D» (fig. 4).

To access the turn indicator bulbs remove screws «E» (fig. 4).

The bulbs have a bayonet coupling: press and twist counter-clockwise about 30° to remove.

Change the burnt out bulb or bulbs and reassemble the parts by performing the above operations in reverse order.

## 4 WHAT TO DO IF... ...THE HEADLIGHT REQUIRES ADJUSTMENT 4.2

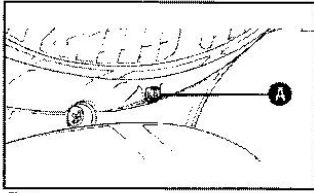

Fig. 1

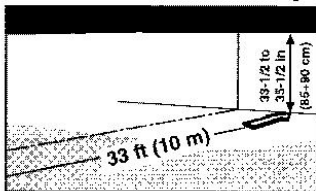

Fig. 2

### ADJUSTING THE HEADLAMP

Set the unladen motorscooter on level, even ground at a distance of 33 ft (10 m) from a flat wall or screen that is sufficiently darkened to be able to see the beam (see fig. 2). Make sure that the motorscooter axis is at right angles to the screen.

Mark the screen with a horizontal line 33-1/2 to 35-1/2 in (85 ÷ 90 cm) from the ground.

Start the engine, switch on the headlight lower beam and position it so that the boundary between the brightly illuminated area and the surrounding area is no higher than the line you have drawn.

To change the position of the headlamp turn the screw «A» on the front of the unit as shown in figure 1.

Before adjusting the headlamp angle, make sure the tires are inflated to the pressure specified on page 58.

72

## 4 WHAT TO DO IF... ...THE REAR-VIEW MIRRORS REQUIRE ADJUSTMENT 4.3

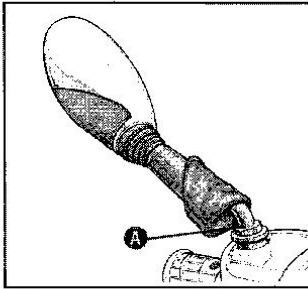

Fig. 1

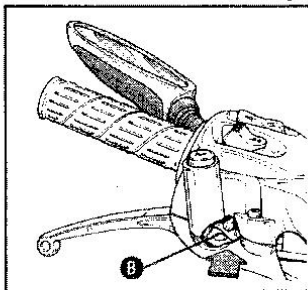

Fig. 2

### ADJUSTING THE REAR-VIEW MIRRORS

To adjust the left hand rear-view mirror (figure 2) set the mirror stem at the required angle and tighten nut «B» using a 13 mm wrench.

The mirror is attached to the stem on a ball and socket joint «A» so it can be positioned quickly and precisely.

Adjust the right hand rear-view mirror as shown in figure 1; when you have secured the stem at the required angle, position the mirror manually (by means of the ball and socket joint).

73

## 4 WHAT TO DO IF... ..IDLE SPEED REQUIRES ADJUSTMENT 4.4

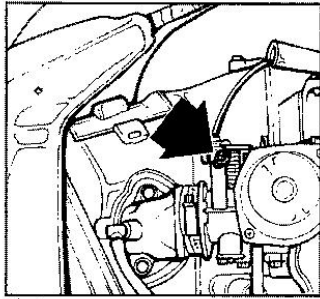

Fig. 1

Remove the helmet compartment to access the idling adjusting screw.

The screw (fig. 1) is used to adjust the idle speed. Adjust the idle speed when the rear wheel is off the ground and the motor scooter is on its stand. Rotate the screw in or out until the engine idles smoothly between 1600 and 1700 rpm.

This adjustment requires an engine revolution counter.

In case you are not able to carry out this adjustment please contact your **Authorized Piaggio/Vespa Service Center**.



### **WARNING**

Danger of burns. Take care not to touch hot engine parts while adjusting idle speed.

74

## 4 WHAT TO DO IF... ..FRONT BRAKE REQUIRES ADJUSTMENT 4.5

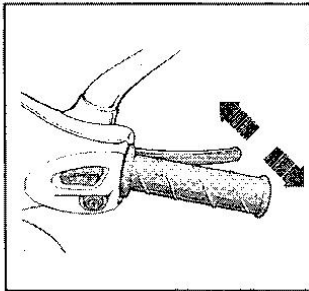
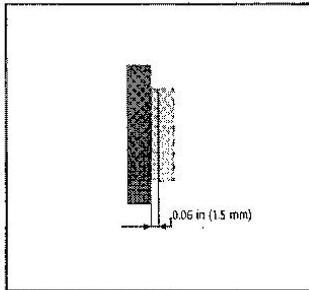

Fig. 1

Fig. 2



### **FRONT DISC BRAKE**

Wear of the disc and brake pads is automatically corrected so there will be no effect on brake efficiency. The brakes therefore require no adjustment. A spongy feel when you pull the lever probably means you have air in the circuit or the brake is malfunctioning. In these cases, keep in mind the importance of your brakes in terms of road safety, we recommend to bring the motor scooter to an **Authorized Piaggio/Vespa Service Center**. He will have the equipment and knowledge to ensure that the front brake is working perfectly.



### **WARNING**

Check the brake pads after the first 625 miles (1,000 km) and every 3,750 miles (6,000 km) thereafter. If the thickness of one or both pads is in the region of 0.06 in (1.5 mm) (see fig. 2), both pads must be changed.

This operation should be carried out by an **Authorized Piaggio/Vespa Service Center**.

Fit only genuine original Piaggio replacement pads.

Non genuine pads might not work perfectly resulting to brake failures and a serious risk of injuries or even death.



### **WARNING**

After fitting new brake pads do not use the motor scooter until you have activated the brake lever repeatedly to bed in the brakes and restore the lever to its correct position.

75

## 4 WHAT TO DO IF...

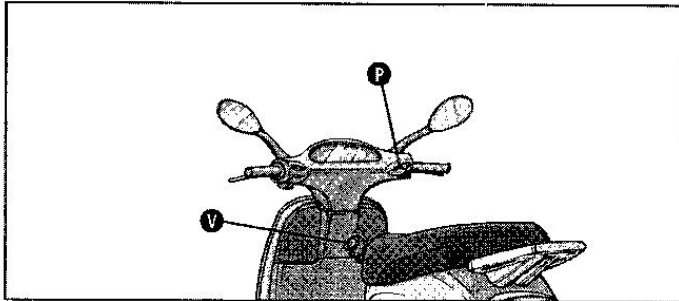

Fig. 1

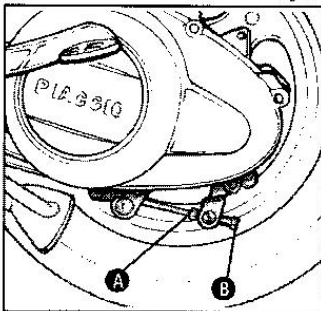

Fig. 2

- Move the engine stop switch «P» (fig. 1) to position "⊗" (OFF).
- Rotate the key and move the ignition switch «V» to position "⊗" (OFF).
- Place the vehicle on the center stand.

### **WARNING**

Be careful not to burn yourself while carrying out the following operations.

### **WARNING**

After you have checked the brakes for function, it is necessary to ensure that there is adequate clearance between the brake shoes and the rear drum. Carry out this check with the engine at rest.

- Stop the vehicle, see p. 39 (STOPPING).

## ...REAR BRAKE REQUIRES ADJUSTMENT 4.6

### REAR BRAKE

Adjust register nut «B» and slacken locknut «A» as shown in figure 1. When adjusting the rear brake remember that the rear wheel must turn freely when **the lever is in the rest position**.

When you have finished adjusting the brake, tighten locknut «A».

### ADJUSTING THE BRAKE

- Measure the distance covered by the lever before the brake starts its braking action.  
The idle stroke at the end of the brake lever must be likewise, about 3/8" (10 mm).

- Apply the brake repeatedly and make sure that the wheel turns freely after the lever has been released.
- Ride the vehicle, ensuring that the rear brake is working properly.

### NOTE

Heat that is generated during normal use of the brakes will change the clearance between the brake shoe and the drum. Because of this, you should check the clearance with the brakes at normal operating temperature.

- Test the brakes after any adjustment to ensure that they function properly.

### **REAR DRUM BRAKE** **WARNING**

The brakes are the parts that most ensure your safety and for this reason they must always be in perfect working order.

If in doubt regarding the perfect functioning of the braking system and in case you are not able to carry out the usual checking operations, contact your local Vespa Dealer.

## 4 WHAT TO DO IF...

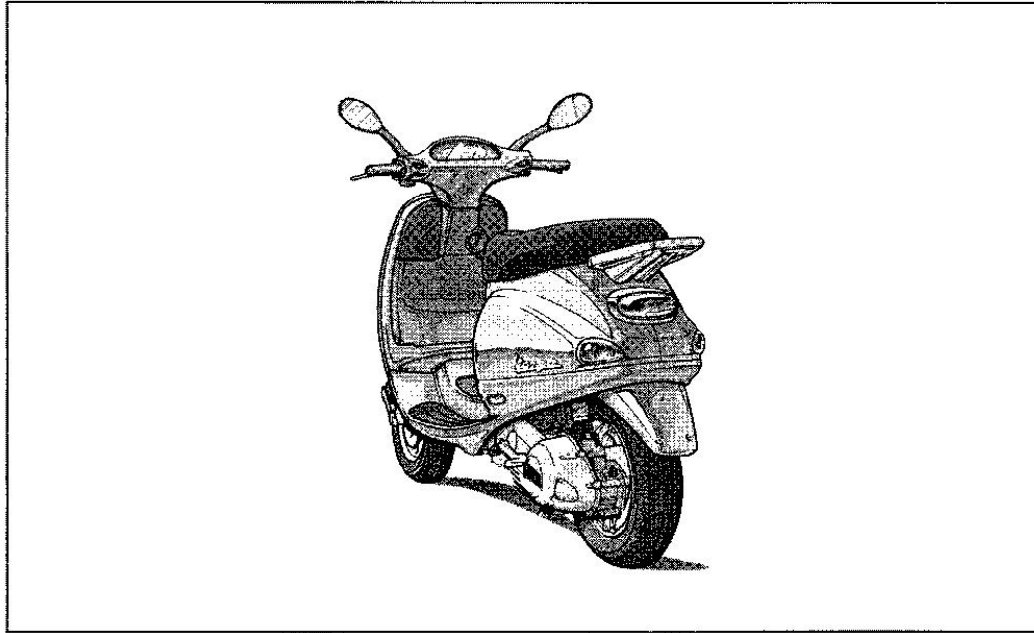

78

## ...REAR BRAKE REQUIRES ADJUSTMENT 4.6

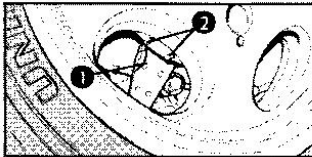

Fig. 3



### **WARNING**

If the adjuster can be screwed completely on to the rear brake rod, or the indicator pointer (1) points beyond the reference tooth (2), the brake shoes are worn out. In this case, please contact your Local Vespa Dealer.



### **WARNING**

Riding with worn rear brake pads can lead to an upset, serious accident, and injury or even death.



### **CAUTION**

After servicing the brakes, always check them for function. If the stroke of the lever is excessive, or if you detect that the effectiveness of the brakes is reduced in any way, have your vehicle serviced by your local Vespa Dealer.

He will have the equipment and knowledge to ensure that the rear brake is working perfectly.

### **NOTE**

For optimal efficiency, the brakes should start to act after approx. 3/8" in. (10 mm) of lever movement.

79



## 4 WHAT TO DO IF...

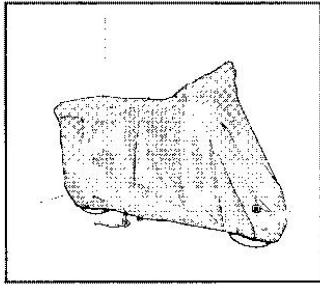

Fig. 1

Prepare the motorscooter as follows:

- 1 - Wash the bodywork thoroughly.
- 2 - With the engine stopped, **remove the spark plug** and pour about 1/16 oz or 27 grains (1±2 cc) of **SELENIA HI SCOOTER 4 TECH** engine oil into the cylinder (piston at bottom of stroke). Now turn over the engine a few times using the kick-starter and then refit the spark plug.
- 3 - Drain the fuel tank and coat unpainted metal parts with protective grease; position the scooter so that the tires are not resting on the ground.
- 4 - For the battery, follow the procedures described on page 68.
- 5 - Drain the gasoline from the carburetor bowl.
- 6 - Change the engine oil.

### **TRANSPORT WARNING**

Before transporting your motorscooter, you must empty the fuel tank and drain the carburetor completely, ensuring that both are completely dry.

While your vehicle is being transported, it must be kept in a vertical position, firmly tied down, and with the wheels blocked.

Failure to heed this warning could cause serious damage to the transmission due to vibration of the transport truck.

## ... YOU NEED TO STORE THE VEHICLE 4.7

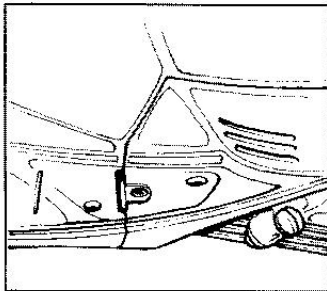

Fig. 2

### **WARNING**

Never attempt to tow your vehicle with another vehicle.

**DRAINING THE FUEL TANK**  
(Carefully read General Safety Rules page 4).

### **DISPOSE OF UNWANTED FUEL PROPERLY**

- Place the vehicle on the center stand.
- Stop the engine and wait until it has cooled down.
- Prepare a container with capacity exceeding the fuel quantity present in the tank and put it on the ground on the left side of the vehicle.
- Remove the filler cap.
- Empty the fuel tank by means of a manual pump or a similar system.

### **WARNING**

After draining the tank, replace the filler cap in correct position.

- Replace the filler cap.

To drain the carburetor completely, proceed as follows:

- Remove the lower side panel (as shown in fig. 2).
- Put the free end of the pipe into a receptacle.
- Open the carburetor outlet by loosening the drain screw positioned under the float chamber (as shown in fig. 3).

When all the fuel has flowed out of the carburetor:

- Tighten the drain screw completely.

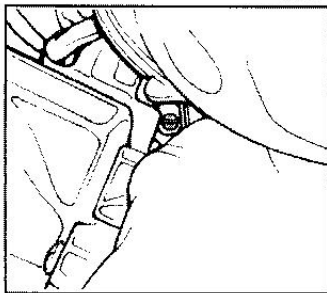

Fig. 3

## 4 WHAT TO DO IF...

## ...YOU NEED TO STORE THE VEHICLE 4.7



### **WARNING**

Risk of fire.

Wait until the engine and the exhaust silencer have completely cooled down. Fuel vapors are noxious and can effect your health.

Before proceeding, make sure that the room in which you are working is properly ventilated.

Do not inhale fuel vapors.

Do not smoke or allow open flames near the vehicle while you are draining the fuel.



### **WARNING**

Tighten the drain screw with care, to avoid fuel leakage from the carburetor during the refuelling.

Do not hesitate to contact your local Vespa Dealer or Authorized Piaggio /Vespa Service Center for help.

## 4 WHAT TO DO IF...

## ...THE VEHICLE NEEDS CLEANING 4.8

To soften up dirt and mud on the painted parts of the scooter, use only a low pressure hose. You can now clean the bodywork with a car wash sponge, plenty of water and car shampoo (2 - 4% concentration in water). Rinse off with plenty of water and dry with a chamois leather. Clean the exterior of the engine with detergent, a brush and clean rags. Always wash the bodywork thoroughly before applying polish. Do not allow water to enter the exhaust pipe or the air vents on the transmission case.



Detergents can pollute rivers, streams and the soil. Do not wash the motorscooter in the road. Respect the environment (limit the amount of soap you use).



### **CAUTION**

Do not wash the motorscooter in the sun - especially in warm weather when the bodywork heats up. In these conditions the detergent will dry before the bodywork can be rinsed and can damage the paintwork. Do not use rags soaked in petrol or diesel to clean painted surfaces or plastic parts of the scooter or damage to the finish may result.



### **CAUTION**

When washing the engine with a water cleaner:

- only use a fan-shaped jet
- keep the nozzle at a distance of at least 2 ft (60 cm)
- do not use water at temperature in excess of 100°F (40°C)

- do not direct the jet towards: the carburetor, electric cables, cooling slits of the transmission cover and the spiral casing.



### **CAUTION**

When cleaning the saddle only use water and detergent.



### **WARNING**

When cleaning the windshield (if installed):

- only use a soft cloth and warm water with a mild detergent
- do not allow any alkaline or strong acid cleaner, gasoline, brake fluid or any other solvent to contact the windshield.

Replace windshield if becomes scratched so as to interfere with view.

## 4 WHAT TO DO IF...

## ...YOU NEED TO PINPOINT A FAULT 4.9

SYMPTOM	POSSIBLE CAUSE	ACTION
Difficulty starting	Fuel tank empty	Refuel
	Filters, jets or carburetor dirty	Contact an <b>Authorized Piaggio/Vespa Service Center</b>
	Dead battery	⚠ Kick-starter. Install new battery
Irregular firing	No spark on spark plug	⚠ Danger: high voltage. This inspection should be carried out by a skilled mechanic. Check the spark plug gap $0.028 \pm 0.031$ in ( $0.7 \pm 0.8$ mm). Check the electrodes for fouling (clean with a proprietary spark plug cleaner and a wire brush). Check the ceramic insulator for cracks or breakage. Change the spark plug if necessary. If the spark plug is in good condition, contact an <b>Authorized Piaggio/Vespa Service Center</b> .
Poor compression	Spark plug thread damaged; head bolts insufficiently torqued; worn piston rings.	Contact an <b>Authorized Piaggio/Vespa Service Center</b>
High fuel consumption and poor performance	Dirty air filter.	Clean with water and neutral detergent as described on page 61.
Poor braking action	Oil on brake drum or disc. Worn brake pads.	Contact an <b>Authorized Piaggio/Vespa Service Center</b>
	Rear brake incorrectly adjusted.	Adjust as described on page 77.
Poor suspension	Oil leak; worn stroke end bumpers; worn shock absorber attachment points.	Contact an <b>Authorized Piaggio/Vespa Service Center</b>
Irregular operation of automatic transmission	Worn roller case or drive belt.	Contact an <b>Authorized Piaggio/Vespa Service Center</b>

## 5 SPECIFICATIONS

## DIMENSIONS

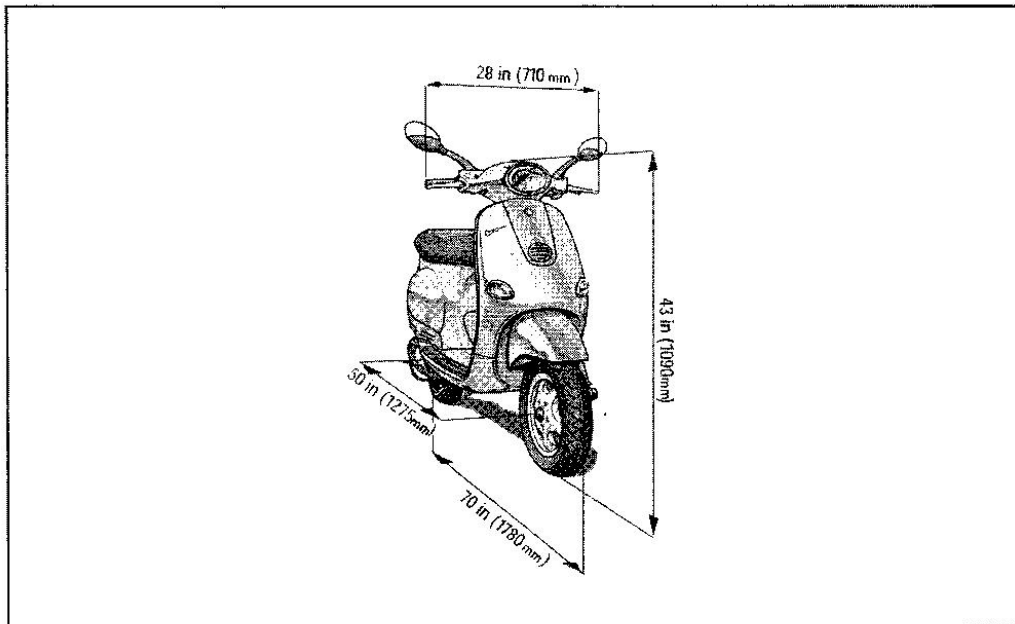

## 5 SPECIFICATIONS

<b>ENGINE</b>	SINGLE CYLINDER 4-STROKE
<b>BORE X STROKE</b>	2.464 x 1.913 in (62.6 x 48.6 mm)
<b>DISPLACEMENT</b>	9.124 in <sup>3</sup> (149.58 cm <sup>3</sup> )
<b>COMPRESSION RATIO</b>	10.1 - 11.1 : 1
<b>IGNITION ADVANCE (BEFORE T.D.C.)</b>	10° @ 1650 rpm 26° @ 6000 rpm
<b>CARBURETOR WALBRO</b>	WALBRO WVF6
<b>SPARK PLUG</b>	CHAMPION RG 6YC
<b>WHEEL-ENGINE TRANSMISSION RATIO</b>	1/21.23 LOW 1/6.36 HIGH
<b>TOP SPEED</b>	60 Mph (97 Km/h)
<b>COLD VALVE CLEARANCE</b>	INTAKE 0.004 in (0.10 mm) EXHAUST 0.006 in (0.15 mm)

### FUEL SYSTEM

Gravity with lead-free gasoline through carburetor.

### LUBRICATION

Engine oil circulation with chain driven lobe pump housed in crankcase. Metal strainer and paper type oil filters.

### COOLING

Air cooled.

### TRANSMISSION

With automatic speed variation system by means of variable diameter pulleys, vee belt, centrifugal clutch and gear final drive.

86

## SPECIFICATIONS AND PERFORMANCE DATA 5.1

### FUEL TANK

Plastic fuel tank; approx. capacity is 2.4 gal (9 l) (including 0.6 gal/2.3 l reserve capacity).

When the fuel light turns on (orange) fuel will be low and you should refill the tank as soon as possible.

The amount of fuel when fuel light turns on is approximately 0.6 gal (2.3 l). The relevant distance is approx 25 mls.

### STEERING AND SUSPENSION

Steering tube connected to front hub; coil spring suspension with hydraulic double acting shock absorber; rear with hydraulic double acting shock absorber and coaxial spring with pre-loading adjustable to 4 positions.

### WHEELS

Front rims 2.5x10", rear rims 3x10" DOT-D light alloy.

### TIRES

Front 100/80-10"; rear 120/70-10". Tubeless Type.

### EXHAUST PIPE

Absorption type.

### ELECTRONIC IGNITION

Capacitive discharge microprocessor system with separate H.T. coil. Integrated immobilizer system.

### FRAME

Structural frame in pressed sheet steel.

### BRAKES

**Front** disc brake with hydraulic linkage (right hand lever).

**Rear** drum brake with mechanical linkage (left hand lever).

### TOOLKIT

Wrenches: one 0.6 in (16 mm) box wrench; one lever bar for 0.6 in (16 mm) wrench; one double screwdriver; one 0.2 in (6 mm) Allen key; one special shock absorber wrench. The tools are located in a toolbox under the saddle.

### CURBSIDE WEIGHT

240 lbs (109 kg).

### CARRYING CAPACITY

422 lbs (191 kg)

#### max technically permissible mass:

on front tire: 220 lbs (100 kg)

on rear tire: 485 lbs (220 kg)

87

## 6 SPARE PARTS AND ACCESSORIES

### SPARE PARTS 6.1

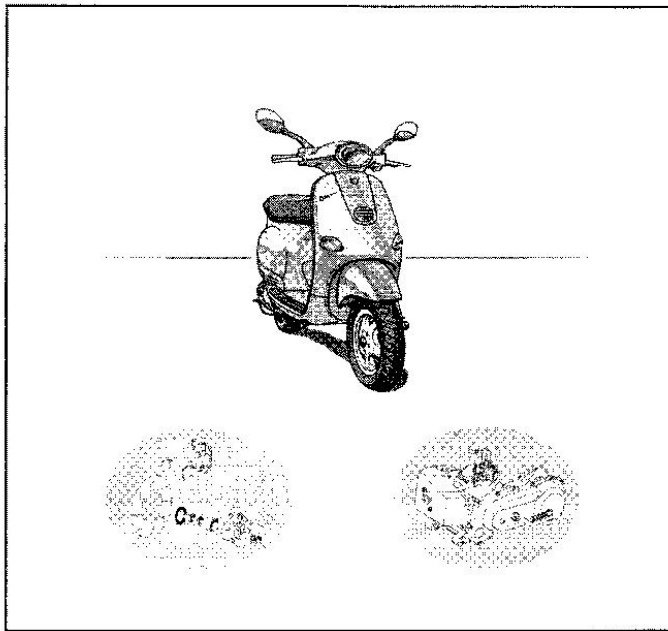



 Use only "ORIGINAL PIAGGIO" spare parts. These are the only components that carry the same guarantee of high quality as the components on the new motorscooter.

88

## 6 SPARE PARTS AND ACCESSORIES

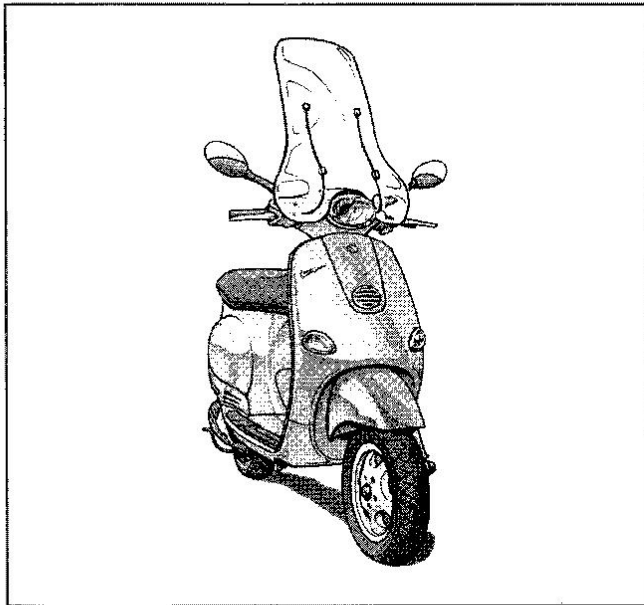
### ACCESSORIES 6.2



 You can choose accessories from the range offered by Piaggio. Only Piaggio accessories are recognized by the manufacturer and are warranted in relation to their use.

To choose any accessories you may require and ensure that they are correctly installed, consult your Local Vespa Dealer or **Piaggio/Vespa Authorized Service Center**.

The use of non-original accessories may affect the stability of your motorscooter and reduce safety levels with possible risks for the rider and passenger.

 **WARNING**

Riding your motorscooter equipped with a windshield over 40 mph can cause instabilities which can lead to upset, serious accident, and injury or even death.

89



## 7 SCHEDULED MAINTENANCE RECOMMENDED PRODUCTS 7.2

TABLE RECOMMENDED PRODUCTS		
USE	CHARACTERISTICS	RECOMMENDED PRODUCT
<b>Rear hub</b>	SAE 80W/90 API GL3 specifications or higher	TUTELA ZC 90
<b>Control cables (brakes, throttle, speedometer)</b>	Four-stroke engine oil	SELENIA HI Scooter 4 Tech
<b>Air filter</b>	Mineral oil with specific tackifier additive ISO VG 150	SELENIA Air Filter Oil
<b>Brake levers, throttle twistgrip</b>	Calcium complex soap grease NLGI 1-2	SYSTEM TW 249 AREXONS
<b>Engine oil</b>	SAE 5W/40 synthetic oil exceeding API SJ specifications ACEA A3 specifications	SELENIA HI Scooter 4 Tech
<b>Speedometer transmission</b>	Lithium soap grease NLGI 3	JOTA 3 FS
<b>Brake fluid</b>	Synthetic SAE J1703, NHTSA 116 DOT 4, ISO 4925	TUTELA TOP 4

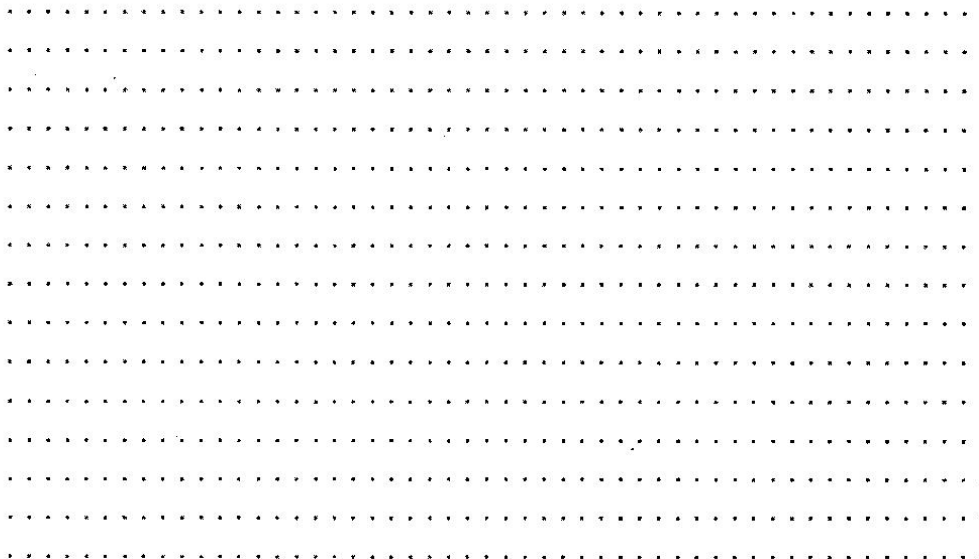

Note: Pages 93, 94, and 95 are blank note sheets as shown above...no missing info.



The descriptions and illustrations supplied in this publication are not to be construed to be a guarantee of any part or component's configuration or material properties. PIAGGIO reserves the right to make modifications to parts or accessories at any time, for any reason, without any obligation to update this booklet. Before attempting any repair operation on your motorscooter, check with your Vespa Dealer or Authorized Piaggio/Vespa Service Center to ensure that you have the latest available information.

Manufacture: Piaggio & C. SpA  
Viale Rinaldo Piaggio, 25  
56025 Pontedera (PISA)  
Italy

Subsidiary: Piaggio USA, Inc.  
20003 South Rancho Way,  
Rancho Dominguez, CA 90220  
USA

© Copyright 2001 - PIAGGIO & C. S.p.A. Pontedera.  
All rights reserved. No part of this publication may be reproduced."

PIAGGIO & C. S.p.A.  
V.le R. Piaggio, 25 - 56025 PONTEDERA (PI), ITALY - Dis. 617257  
[www.vespa.com](http://www.vespa.com)

