

PIAGGIO WOULD LIKE TO THANK YOU

for choosing one of its products. We have prepared this manual to help you to get the very best from your vehicle. Please read it carefully before riding the vehicle for the first time. It contains information, tips and precautions for using your vehicle. It also describes features, details and devices to assure you that you have made the right choice. We believe that if you follow our suggestions, you will soon get to know your new scooter and it will serve you well for a long time to come. This booklet forms an integral part of the vehicle; should the vehicle be sold, it must be transferred to the new owner.

# LUM Beverly Sport Touring ABS-ASR



The instructions given in this manual are intended to provide a clear, simple guide to using your vehicle; this booklet also details routine maintenance procedures and regular checks that should be carried out on the vehicle at an **authorised Dealer or Service Centre**. The booklet also contains instructions for simple repairs. Any operations not specifically described in this booklet require the use of special tools and/or particular technical knowledge: to carry out these operations, refer to any **authorised Dealer or Service Centres**.



### **Personal safety**

Failure to completely observe these instructions will result in serious risk of personal injury.



### **Safeguarding the environment**

Sections marked with this symbol indicate the correct use of the vehicle to prevent damaging the environment.



### **Vehicle intactness**

The incomplete or non-observance of these regulations leads to the risk of serious damage to the vehicle and sometimes even the invalidity of the guarantee.

*The signs that you see on this page are very important. They are used to highlight parts of the booklet that should be read with particular care. The different symbols are used to make each topic in the manual simple and quick to locate.*



# INDEX

<b>VEHICLE</b> .....	7	Starting up the engine.....	39
Dashboard.....	8	Precautions.....	40
Analogue instrument panel.....	9	Stopping the engine.....	41
Clock.....	11	Stand.....	41
Digital lcd display.....	13	Automatic transmission.....	42
*MODE* button.....	13	Safe driving.....	43
Key switch.....	13	<b>MAINTENANCE</b> .....	47
Locking the steering wheel.....	14	Engine oil level.....	48
Releasing the steering wheel.....	14	Engine oil level check.....	48
Switch direction indicators.....	15	Engine oil top-up.....	49
Horn button.....	15	Warning light (insufficient oil pressure).....	49
Light switch.....	16	Engine oil change.....	50
Start-up button.....	16	Hub oil level.....	51
Engine stop button.....	17	Tyres.....	53
System ABS.....	17	Spark plug dismantlement.....	54
System ASR.....	18	Removing the air filter.....	55
The immobilizer system.....	23	Air filter cleaning.....	56
Keys.....	23	Cooling fluid level.....	57
Immobilizer device enabled indicator led.....	24	Checking the brake oil level.....	59
Operation.....	24	Braking system fluid top up.....	59
Programming the immobilizer system.....	25	Battery.....	63
Accessing the fuel tank.....	27	Use of a new battery.....	64
Power supply socket.....	27	Long periods of inactivity.....	65
Opening the saddle.....	28	Fuses.....	66
Identification.....	28	Lamps.....	68
Rear top box opening.....	30	Front light group.....	70
Bag clip.....	31	Headlight adjustment.....	71
<b>USE</b> .....	33	Front direction indicators.....	72
Checks.....	34	Rear optical unit.....	73
Refuelling.....	34	Number plate light.....	74
Tyre pressure.....	36	Helmet compartment lighting bulb.....	75
Shock absorbers adjustment.....	37	Rear-view mirrors.....	75
Running in.....	38	Front and rear disc brake.....	76

Puncture.....	77
Periods of inactivity.....	78
Cleaning the vehicle.....	78
Troubleshooting.....	80
<b>TECHNICAL DATA.....</b>	<b>83</b>
Toolkit.....	88
<b>SPARE PARTS AND ACCESSORIES.....</b>	<b>89</b>
Warnings.....	90
<b>SCHEDULED MAINTENANCE.....</b>	<b>93</b>
Scheduled servicing table.....	94

# LUM Beverly Sport Touring ABS- ASR



**PIAGGIO®**



**Chap. 01  
Vehicle**

## Dashboard (01\_01)



01\_01



- A** = Ignition switch
- B** = Bag hook
- C** = Saddle opening button
- D** = Horn button
- E** = Turn indicator switch
- F** = Rear brake lever
- G** = Light switch with passing
- H** = Instrument panel
- I** = Emergency stop switch RUN-OFF
- L** = Front brake lever
- A** = Starter button
- N** = MODE button
- O** = ASR control button

### **Analogue instrument panel (01\_02)**

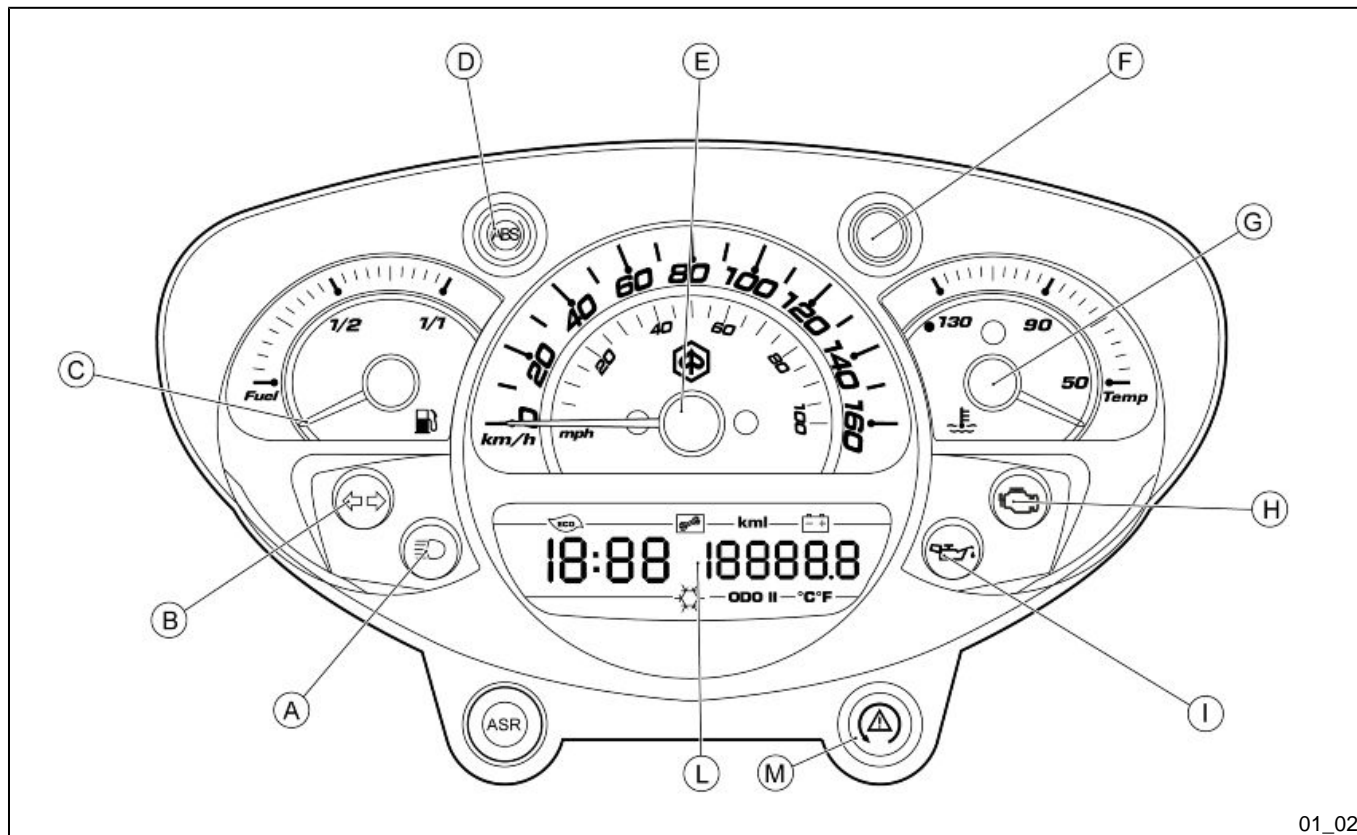

01\_02

A= High beam warning light

B = Turn indicator warning lights

- C** = Fuel gauge
- D** = ABS warning light
- E** = Speedometer
- F** = Immobiliser LED
- G** = Coolant temperature gauge
- H** = Engine control telltale light
- I** = Engine oil pressure warning light
- L** = Digital display
- M** = ASR warning light

### **Clock (01\_03, 01\_04, 01\_05, 01\_06)**

Use the switch "MODE" to "ODO" mode

Hold the switch "MODE" for more than 3 seconds, the hours will be displayed. Hours will increase each time the "MODE" button is pressed.

Once the hour is adjusted, hold the switch "MODE" more than 3 seconds to display the minutes. Minutes will increase each time the "MODE" button is pressed.

If no key is pressed for 3 seconds, the system will leave the clock adjustment mode.

#### **WARNING**

**FOR SAFETY REASONS THE TIME SETTING IS ONLY POSSIBLE WITH THE VEHICLE AT A STANDSTILL.**





01\_04



01\_05



01\_06

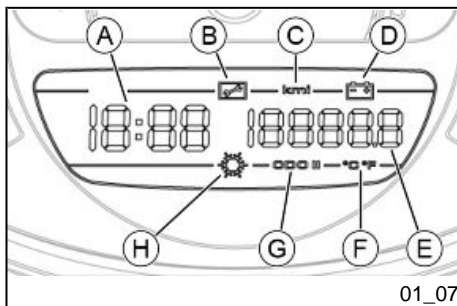

01\_07

## Digital lcd display (01\_07)

**A** = Clock

**B** = «SERVICE» icon

**C** = Kilometre-mile indicator

**D** = State of battery charge icon

**E** = Odometer indicator, partial odometer I and II, state of battery charge and cyclically selectable ambient temperature with the «MODE» button

**F** = Ambient temperature indicator in degrees Celsius or Fahrenheit

**G** = Indicator «ODO», «ODO I» or «ODO II»

**H** = Low ambient temperature icon



01\_08

## \*MODE\* button (01\_08)

Pushing the **MODE** button «A» for less than a second displays the following sequence of functions:

- Total Odometer «ODO»
- Partial Odometer «ODO I»
- Partial Odometer «ODO II»
- State of battery charge
- Ambient temperature «°»

To reset the trip odometer, move «ODO I» or «ODO II» and press for more than three seconds the button **MODE** «A».

## Key switch (01\_09)

Ignition key «A» is located on the front leg shield back plate near the bag hook.



### SWITCH POSITIONS

**ON «1»:** Ready to start position, non-extractable key, mechanical antitheft device disabled.

**OFF «2»:** Ignition disabled, extractable key, mechanical antitheft device disabled.

**LOCK «3»:** Ignition disabled, extractable key, mechanical antitheft device enabled.



### Locking the steering wheel (01\_10)

Turn the handlebar to the left (as far as it will go), turn the key to «**LOCK**» and remove the key.



### Releasing the steering wheel (01\_11)

Reinsert the key and turn it to «**OFF**».

### Switch direction indicators (01\_12)

Move switch «A» to the left to indicate a left turn; move switch «A» to the right to indicate a right turn. Push the central part of switch «A» to deactivate the turn indicators.



### Horn button (01\_13)

Press the «A» button to sound the horn.



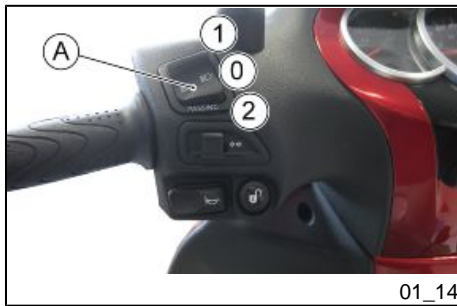

01\_14

### Light switch (01\_14)

When the light switch «A» is in position «0» the low-beam light is ON; when it is in position «1» the high-beam light is ON. If the light switch «A» is pressed when set to «2», the high-beam light flashing is activated. The switch goes back to «0» automatically.

#### CAUTION



**DO NOT PLACE, TRANSPORT OBJECTS AND/OR CLOTHES OVER THE FRONT HEADLIGHT ASSEMBLY, WHEN THE HEADLIGHT IS TURNED ON OR OFF. FAILURE TO FOLLOW THIS PRECAUTION MAY CAUSE OVERHEATING AND THE SUBSEQUENT FUSION OF THE GLASS.**



01\_15

### Start-up button (01\_15)

Starter button «A». To start the vehicle, refer to the "starter motor" section.





01\_16

### Engine stop button (01\_16)

The engine can be started when the emergency stop switch «A» is in position «1» **RUN**; if the emergency stop switch «A» is in position «0» **OFF** the engine cannot be started or it stops if it was running.

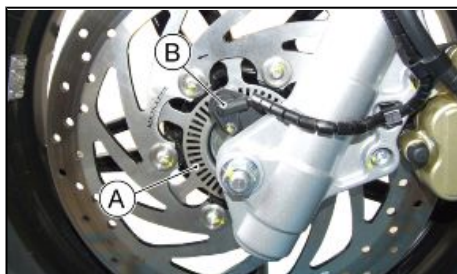

01\_17

### System ABS (01\_17)

The vehicle is equipped with a locking ABS system on the wheels.

**A: Tone wheel**

**B: Speed sensor**

- **ABS:** It is a hydraulic - electronic device that limits the pressure within the braking circuit when a sensor, located on the wheel, detects its tendency to lock. This system prevents the wheels from locking to avoid the risk of falling.

In case of failure of the ABS system, immediately reported to the rider with ABS warning light on the instrument panel, the vehicle retains the characteristics of a conventional braking system. In case of ABS warning light, reduce speed and go to an Authorised Service Centre for the appropriate checks. The safety provided by the ABS does not, in any case, justify risky manoeuvres. The stopping distance may be greater, compared to a conventional vehicle equipped with traditional braking in the following conditions:

- Riding on rough roads, with gravel or snow
- Riding on roads with holes or bumps

It is therefore recommended to reduce speed in these conditions.

**WARNING**

THE VEHICLE IS EQUIPPED WITH SERVO ASSISTED BRAKES.



AT VERY LOW SPEEDS (LESS THAN 5 KM/H) THE ABS SYSTEM IS DISABLED.

IT IS RECOMMENDED TO PAY ATTENTION THEREFORE IN CASES OF BRAKING IN LOW GRIP CONDITIONS AT LOW SPEED (FOR EXAMPLE BRAKING ON GARAGE FLOOR TILES AFTER HAVING RIDDEN ON WET ROADS OR SIMILAR SITUATIONS)

**N.B.**

THE ABS WARNING LIGHT TURNS ON AND STAYS ON UNTIL REACHING 5 KM/H.

**CAUTION**

IN THE EVENT OF MALFUNCTION OF THE BATTERY, THE ABS - ASR SYSTEM TURNS OFF

**System ASR (01\_18, 01\_19)****ASR SYSTEM**

The ASR system is a device to help riding that helps the rider during acceleration manoeuvres, especially on slippery surfaces or in conditions that can cause sudden slippage of the rear wheel. The ASR in these situations automatically intervenes by reducing engine output within the limit imposed by the grip conditions, contributing significantly to the maintenance of stability the vehicle.

**WARNING**

THE ASR SYSTEM IS BASED ON THE RECOGNITION OF SPEED DIFFERENCES BETWEEN FRONT AND REAR WHEEL. IN ORDER FOR THE SYSTEM TO MAINTAIN MAXIMUM EFFICIENCY IN ALL CONDITIONS, THE CALIBRATION PROCEDURE **MUST BE PERFORMED EVERY TIME, EVEN IN CASE OF REPLACEMENT OF JUST ONE TYRE.**

**FOR THE CALIBRATION OF THE CONTROL UNIT PERFORM THE PROCEDURE BELOW.**



01\_18

- **SWITCH «1»:** on / off.
- **WARNING LIGHT «2»:** operating indication warning light.

**Flashing mode:**

- Off with the vehicle in gear: the system is working, but is not active (normal condition).

- Flashing quickly with moving vehicle: the system is up and running (conditions of low grip and intervention to reduce engine power); we recommend the utmost caution because the grip limit has been exceeded; restore the vehicle safety conditions by gently reducing the throttle opening.

- Lit with moving vehicle: the system is disabled and will not intervene in case of loss of grip.

- If the deactivation was voluntary (by pressing the appropriate button «1» for 1 second) it is recommended to replace the system as soon as possible.
- If the deactivation was NOT voluntary, there is an ASR failure: in this case you must contact an **Authorised Service Centre** for the diagnosis and the reactivation of the system.

To ensure maximum safety of the vehicle it is advisable to keep the system active. Deactivation may be necessary only in case of starting with very low grip surfaces (mud, snow) on which the operation of the ASR could actually prevent the movement of the vehicle.

**N.B.**

AT VEHICLE START-UP THE ASR WARNING LIGHT FLASHES AT THE SAME FREQUENCY AS THE ABS WARNING LIGHT, INDICATING A DIAGNOSTIC PHASE OF THE SYSTEM. IN THE ABSENCE OF ERRORS, BOTH WARNING LIGHTS TURN OFF AT THE SAME TIME WHEN EXCEEDING 5 KM/H.

IN CASE OF ABSENCE OF FLASHING AT START-UP, THE SYSTEM MAY NOT WORKING, PLEASE CONTACT AN AUTHORISED SERVICE CENTRE.

**WARNING**

THE ASR SYSTEM IS ACTIVATED AT EVERY «ON» POSITIONING OF THE IGNITION SWITCH.

IF DISABLED BY THE USER, THE ASR SYSTEM KEEPS THE STATE OF INACTIVITY ONLY IF THE VEHICLE IS OFF, BY USING THE ENGINE STOP SWITCH; AT THE NEXT KEY ON THE ASR SYSTEM IS ENABLED AUTOMATICALLY.

**CAUTION**

IT IS EMPHASISED THAT THE RIDING AUXILIARY SYSTEM CAN NOT CHANGE THE PHYSICAL LIMITS OF GRIP AND IS NOT A SUBSTITUTE FOR PROPER MANAGEMENT OF POWER, BOTH ON STRAIGHT STRETCHES AND IN TURNS. THEREFORE, IT IS RECOMMENDED TO ALWAYS USE THE VEHICLE WITH THE UTMOST CARE AND IN ACCORDANCE WITH THE REGULATIONS IN FORCE.

**CAUTION**

AT LOW SPEED (LESS THAN 5 KM/H), THE ASR SYSTEM DOES NOT WORK.

**IT IS RECOMMENDED TO PAY PARTICULAR ATTENTION IN THE EVENT OF ACCELERATION FROM STANDSTILL IN CONDITIONS OF LOW GRIP, ESPECIALLY IN THE FIRST METRES.**

**N.B.**

**IN CASE OF ROADS FULL OF HOLES THERE MAY OCCUR BRIEF ACTIVATION OF THE ASR SYSTEM. THIS OCCURS UNDER NORMAL OPERATING CONDITIONS OF THE VEHICLE.**

**N.B.**

**THE DEVICE PREVENTS IMPRESSING ON THE REAR HIGH SPEED ROTATION WHEEL WITH THE VEHICLE ON THE CENTRE STAND. IT IS RECOMMENDED NOT TO INSIST WITH THE THROTTLE GRIP IN THIS PARTICULAR CONDITION.**

**CAUTION**



**A POOR STATE OF MAINTENANCE OF THE TYRES CAN RESULT IN ABNORMAL OPERATION OF THE ASR SYSTEM.**

**IN CASE OF REPEATED INTERVENTIONS OF THE ASR, EVEN ON ROAD SURFACES WITH GOOD GRIP OR SMALL THROTTLE OPENINGS, IT IS NECESSARY TO CHECK FOR WEAR AND/OR THE STATE OF INFLATION OF TYRES FIRST. IF THE PROBLEM PERSISTS, CONTACT AN AUTHORISED SERVICE CENTRE.**

**CAUTION**



**IN THE EVENT OF MALFUNCTION OF THE BATTERY, THE ABS - ASR SYSTEM TURNS OFF**

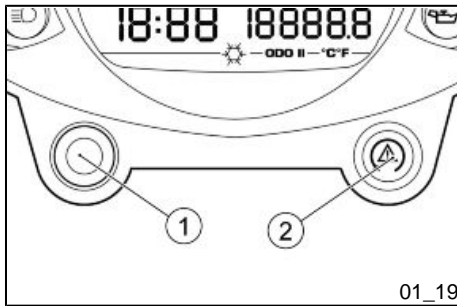

### ASR SYSTEM CALIBRATION PROCEDURE.

In order to maintain the effectiveness of the ASR system following the replacement of one or both tyres a calibration procedure of the system must be performed as follows on a straight flat stretch of road.

- It is necessary that the diagnostic phase of the ASR systems and ABS is complete: for this purpose, after the key ON, ride a short distance above 5 km/h and wait for the flashing of the two warning lights to stop.
- Turn the ASR system off by pressing the button «1» on the handlebar and check that the ASR disabling warning light «2» is on.
- Allow the engine to idle for at least 3 seconds.
- Press simultaneously the right brake lever, the engine start-up button and the ASR on/off button «1» for at least 2 seconds. The activation process will be confirmed by the ASR warning light «2» turning on with slow flashing.
- Accelerate to a constant speed of **30 to 40 km/h** and maintain it for at least **7 to 8** seconds.
- The end of the procedure will be indicated by the flashing ASR warning light «2».
- Once the procedure is complete it is necessary to turn off the vehicle panel (key off) and wait 30 seconds before turning the panel on (key on).
- In case of failure to complete the procedure within 2 minutes the ASR warning light «2» will stay on steady and the ASR will remain off until the panel is turned off (key off).
- To restart the vehicle panel (key on) it is necessary to reactivate the ASR. It is however necessary to repeat the process until it succeeds.

### CAUTION



**IF NECESSARY, CONTACT AN AUTHORISED SERVICE CENTRE.**

## The immobilizer system

In order to enhance theft protection, the vehicle is equipped with a «**PIAGGIO IMMOBILIZER**» electronic engine locking device that is activated automatically when the ignition switch is removed. Upon start-up, the «**PIAGGIO IMMOBILIZER**» system checks the starter key, and only if this key is recognised will the Immobiliser system allow the vehicle to be started.

### Keys (01\_20, 01\_21, 01\_22)

Two types of keys are supplied together with the vehicle.

Key «**A**» is the «**MASTER**» key.

Only a single copy of this key is supplied, which is necessary to program all your other keys and for your dealer to perform some maintenance operations. For this reason it is advised that it be used only in exceptional circumstances.

The key «**B**» (single copy supplied) is used for regular operations such as:

- Engine starter
- Opening fuel tank cap

Together with the two keys, you will be given a CODE CARD bearing the same code imprinted onto the two keys.

#### WARNING



**LOSING THE MASTER KEY PREVENTS ANY FURTHER REPAIR OF THE "PIAGGIO IMMOBILISER" SYSTEM AND OF THE ENGINE CONTROL UNIT.**

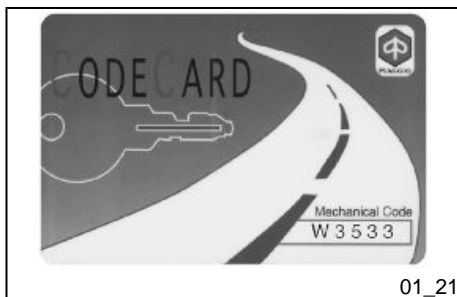
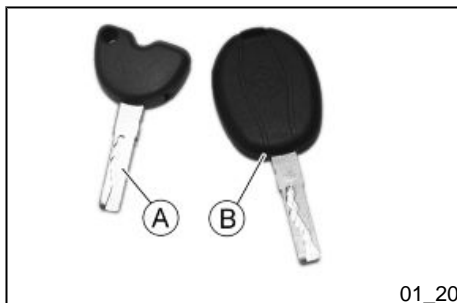

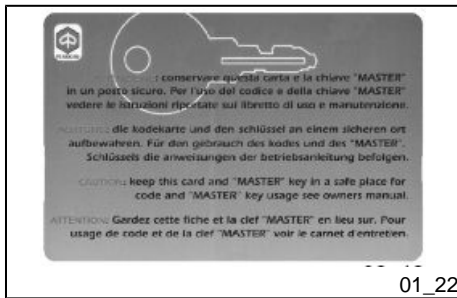

01\_22

**WARNING**

**KEEP THE "CODE CARD" AND THE MASTER KEY IN A SAFE PLACE (NOT IN THE VEHICLE).**

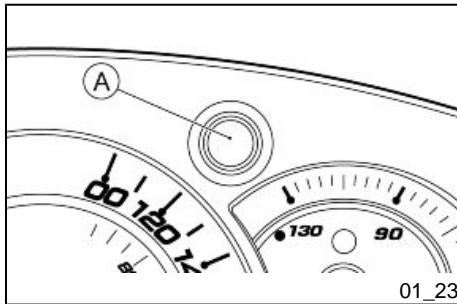

01\_23

**Immobilizer device enabled indicator led (01\_23)**

The activation of the «**PIAGGIO IMMOBILISER**» system is signalled by the a flashing indicator «**A**».

In order to reduce battery discharge, the indicator LED turns off automatically after 48 hours of uninterrupted functioning.

Should the system fail, different LED flashing patterns will provide the **Authorised Service Centre** with information on the type of fault detected.

**Operation**

Each time the ignition switch **B** is removed while in the «**OFF**» or «**LOCK**» positions, the protection system activates the engine lock. Turning the ignition key «**B**» to «**ON**» disables the engine lock, provided that the safety system recognises the code transmitted by the key. If the code is not recognised, turn the ignition switch **B** first to «**OFF**» and then back to «**ON**» again; if lock persists, try again using the «**A**» **MASTER** key. If the engine cannot be started, contact an **Authorised Service Centre**, which is provided with the electronic equipment required to detect and repair the system.



When the supplementary starter keys are required, remember that all the keys, whether new or existing, should be programmed.

Contact an **Authorised Service Centre** and bring the «**A**» MASTER key and all «**B**» starter keys that you own.

The codes of starter keys not submitted for the new programming procedure are deleted from the memory. Any lost starter keys will therefore not be enabled to start the engine.

#### **WARNING**



**EACH KEY HAS ITS OWN AND UNIQUE CODE, WHICH MUST BE STORED IN THE SYSTEM CONTROL UNIT MEMORY.**

**VIOLENT SHOCKS MAY AFFECT THE ELECTRONIC COMPONENTS OF THE KEY.**

**IF THE VEHICLE IS SOLD, THE MASTER-HANDGRIP KEY (AS WELL AS THE OTHER STARTER KEYS) AND THE «CODE CARD» MUST ALSO BE TRANSFERRED TO THE NEW OWNER.**

### **Programming the immobilizer system (01\_24)**

Below is described the procedure to follow for programming the **PIAGGIO IMMOBILISER** system and/or for storing other key codes. The programming procedure should be carried out with the engine stop switch set to «**RUN**».

#### **START PROCEDURE**

Insert the «**MASTER**» key «**A**» into the ignition switch (in «**OFF**») and turn it to «**ON**». After 1 - 3 seconds, turn the key to «**OFF** » again and pull it out.

### INTERMEDIATE STAGE

After extracting the «MASTER» key «A», insert, within ten seconds, the key that is going to be programmed «B» and turn it immediately to «ON». After 1-3 seconds, turn the key to «OFF» again and pull it out. In this way, a maximum of 5 keys can be programmed by repeating the above procedure and keeping the indicated times.

### FINAL STAGE

After extracting the key to be programmed «B», insert the «MASTER» key «A» again and turn it to «ON» (perform this operation within the 10 seconds following the extraction of the previous key). Leave it in this position for 1 to 3 seconds and return it to «OFF».

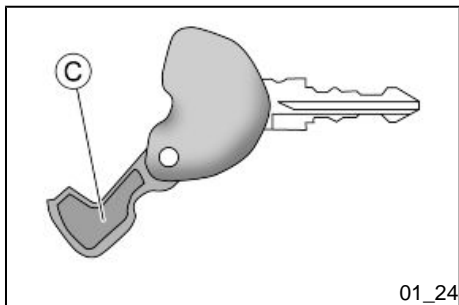

### CORRECT PROGRAMMING CHECK PHASE

Insert the «MASTER» key «A» disabling the transponder «C» (i.e., by tilting the key cap by 90°), and turn the key to «ON». Perform the engine starter operation. Ensure that the engine does not start. Insert the programmed key «B» and repeat the starter operation. Check that engine starts.

### WARNING



**SHOULD YOU START THE ENGINE WITH THE MASTER KEY (WITH TRANSPONDER OFF) OR IN THE EVENT OF WRONG OPERATION DURING PROGRAMMING, REPEAT THE PROCEDURE FROM THE BEGINNING.**



01\_25

### Accessing the fuel tank (01\_25)

Raise the lock protection tab on the fuel tank cap. Insert the key and turn anticlockwise to remove the cap.



01\_26

### Power supply socket (01\_26)

There is a plug socket inside the front case.

The plug socket may be used for external consumers (mobile phone, inspection light, etc.).

#### CAUTION



**PROLONGED USE OF THE PLUG SOCKET MAY RESULT IN PARTIAL DISCHARGE OF THE BATTERY**

#### Electric characteristic

##### Plug socket

12 V - 180 W MAX

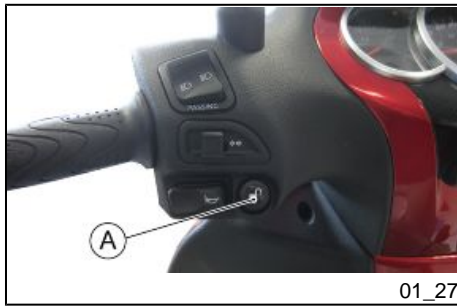

### Opening the saddle (01\_27, 01\_28)

With the key in position «OFF» or «ON» or with the engine ON, you can electrically open the saddle by pressing button «A». If the electric opening does not work, use the emergency lever **B**.

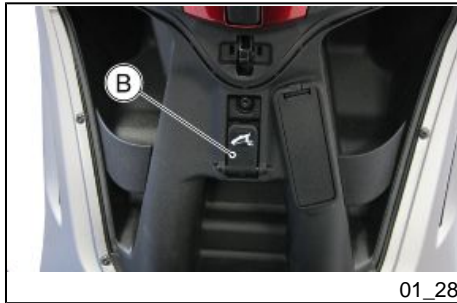

### Identification (01\_29, 01\_30, 01\_31)

Identification registration numbers are made up of a prefix and a number, stamped on the chassis and on the engine. These numbers must always be quoted when ordering spare parts. We recommend checking that the chassis registration number stamped on the vehicle corresponds with that on the vehicle documentation.

**CAUTION**

**BE REMINDED THAT ALTERING IDENTIFICATION REGISTRATION NUMBERS CAN LEAD TO SERIOUS PENAL SANCTIONS (IMPOUNDING OF THE VEHICLE, ETC.).**

**Chassis number**

To read the chassis number, remove the port **A** in the front case.





### Engine number

The engine number «B» is stamped near the rear left shock absorber lower support.

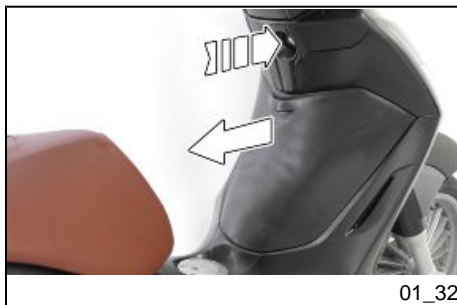

### Rear top box opening (01\_32)

Insert the key into the switch and press down until the glove compartment opens. In the event that the switch is in «**LOCK**», turn the key to «**OFF**» or «**ON**» before pressing it.

**Bag clip (01\_33)**

To use retractile bag hook mounted on the leg shield back plate, it is necessary to turn it towards the rear part of the vehicle pressing where indicated by the arrow.



01\_33





# LUM Beverly Sport Touring ABS- ASR



**PIAGGIO®**



**Chap. 02  
Use**

## Checks

Before using the vehicle, check:

1. That the fuel tank is full.
2. The front and rear brake fluid level.
3. That the tyres are properly inflated.
4. Correct functioning of daylight running lights, headlight, and turn indicators.
5. The correct functioning of front and integral brakes.
6. The oil level in the gearcase.
7. The engine oil level.
8. Coolant level



02\_01

## Refuelling (02\_01)

Raise the lock protection tab on the fuel tank cap. Insert the key and turn anticlockwise to remove the cap.

### WARNING



**SWITCH OFF THE ENGINE BEFORE REFUELLING WITH PETROL.**

**PETROL IS HIGHLY INFLAMMABLE.**

**DO NOT SMOKE AND KEEP NAKED FLAMES AT A DISTANCE: FIRE HAZARD.**

**DO NOT INHALE FUEL FUMES.**

**DO NOT ALLOW PETROL TO COME INTO CONTACT WITH HOT ENGINE OR ANY PLASTIC PARTS.**

**CAUTION**



**DO NOT USE THE VEHICLE TO THE COMPLETE EXHAUSTION OF THE FUEL; SHOULD THIS OCCUR, DO NOT ATTEMPT TO START THE ENGINE. TURN THE IGNITION SWITCH TO «OFF» AND TOP-UP THE TANK AS SOON AS POSSIBLE. FAILURE TO FOLLOW THESE GUIDELINES COULD DAMAGE THE FUEL PUMP AND/OR THE CATALYTIC CONVERTER.**

**CAUTION**



**CLEAN IMMEDIATELY THE PAINTED OR PLASTIC SURFACES THAT COME INTO CONTACT WITH THE FUEL TO AVOID LOSS OF THEIR SHINE OR ALTERATION OF THEIR MECHANICAL CHARACTERISTICS.**

**Characteristic**

**Fuel tank**

13 | ± 1

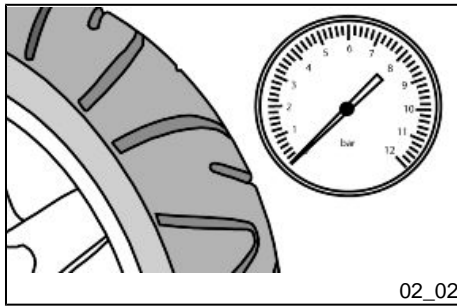

## Tyre pressure (02\_02)

Check tyre pressure and wear periodically as indicated in the scheduled maintenance table. Tyres feature wear indicators; replace tyres as soon as these indicators become visible on the tyre tread. Also check that the tyres do not show signs of splitting at the sides or irregular tread wear; if this occurs, go to an authorised workshop or at least to a workshop equipped to replace tyres.

### CAUTION



**TYRE PRESSURE SHOULD BE CHECKED WHEN TYRES ARE COLD. INCORRECT TYRE PRESSURE CAUSES ABNORMAL TYRE WEAR AND MAKES RIDING DANGEROUS.**

**TYRES MUST BE REPLACED WHEN THE TREAD REACHES THE WEAR LIMITS SET FORTH BY LAW.**

## TYRE INFLATION PRESSURE

Front tyre pressure (with passenger)	2.2 bar (2.2 bar)
Rear tyre pressure (with passenger)	2.4 bar (2.6 bar)

## TYRES

Front tyre	110/70 - 16" M/C 52S Tubeless
Rear tyre	150/70 - 14" M/C 66S Tubeless

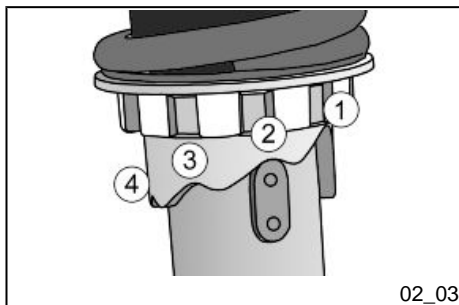

02\_03

## Shock absorbers adjustment (02\_03, 02\_04)

The preloading of the springs can be adjusted to 4 positions acting on the ring nut located in the lower part of the shock absorbers with the specific spanner supplied.

**Position 1:** minimum preload: rider only

**Position 2** medium preloading: rider only

**Position 3** medium preloading: rider and passenger

**Position 4:** maximum preloading: rider, passenger, and luggage.

In order to carry out this operation you will need to use the specific spanner in the kit. Spring preloading increases by turning the ring nut towards «A», but decreases if the ring nut is turned towards «B».

### CAUTION



**RIDING THE VEHICLE WITH THE SPRING PRELOADING NOT CORRECTLY SET FOR THE RIDER AND POSSIBLE PASSENGER, COULD REDUCE THE COMFORT OF THE RIDE AND THE PRECISION OF THE STEERING.**

### WARNING



**WE RECOMMEND WEARING GLOVES WHILE CARRYING OUT THIS OPERATION IN ORDER TO AVOID INJURIES.**

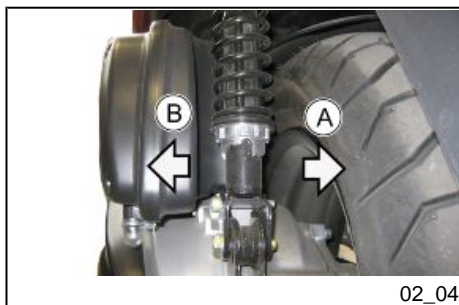

02\_04

**WARNING**

**IT IS ABSOLUTELY FORBIDDEN TO ADJUST THE PRELOAD DIFFERENTLY ON THE TWO SHOCK ABSORBERS**

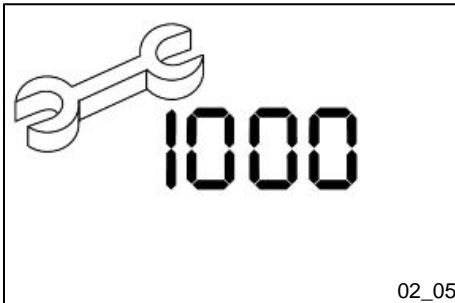
**Running in (02\_05)**

**DURING THE FIRST 1000 KM. DO NOT RIDE THE VEHICLE OVER 80% OF ITS MAX. SPEED. AVOID OPENING THE THROTTLE GRIP COMPLETELY OR KEEPING A CONSTANT SPEED ALONG LONG SECTIONS OF ROAD. AFTER THE FIRST 1000 KM. INCREASE SPEED PROGRESSIVELY, IF POSSIBLE, UNTIL THE MAXIMUM PERFORMANCE IS OBTAINED.**

**CAUTION**

**IN ORDER TO AVOID DAMAGING THE VEHICLE, PLEASE COMPLY WITH THE RULES LISTED ABOVE.**

## Starting up the engine (02\_06, 02\_07, 02\_08)

The vehicle is equipped with an ignition prevention system controlled by the side stand.

The engine cannot be started if the side stand is lowered.

If the engine is on, it will turn itself off if the side stand is lowered.

To start the engine it is necessary, before pressing the starter button, to pull and keep pulled the front or rear brake lever, which activates the appropriate switch allowing start-up.

- Rest the vehicle on its centre stand, making sure that the rear wheel is not touching the ground.

- Keep the throttle grip at idle speed.

- Insert the key into the ignition switch «A» and turn it to «ON».

- Make sure that the emergency stop switch «B» is in position «RUN» and the side stand is up and not engaged.

- Pull either the front, «C» or rear «D» brake lever and then press the starter button «E».

### WARNING



**THE AUTOMATIC TRANSMISSION MAKES THE REAR WHEEL TURN EVEN WHEN THE THROTTLE IS SLIGHTLY TWISTED. RELEASE THE BRAKE CAREFULLY AFTER STARTING, AND THEN ACCELERATE GRADUALLY.**

### CAUTION

**DURING THE RUN-IN PERIOD, IT IS POSSIBLE THAT THE REAR WHEEL WITH THE ENGINE IDLE AND THE VEHICLE ON THE STAND, MAY TURN SLIGHTLY; THIS PHENOMENON SHOULD BE CONSIDERED NORMAL AND USUALLY DISAPPEARS AFTER A SHORT PERIOD OF USE.**



02\_06

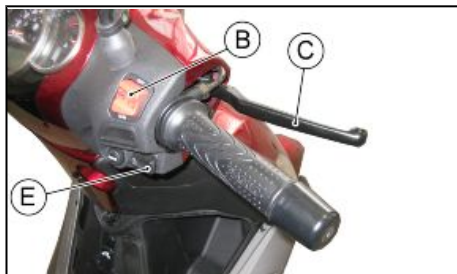

02\_07

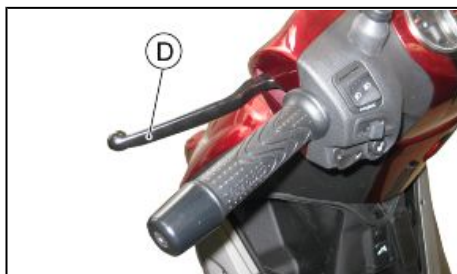

02\_08

## CAUTION



**DO NOT START-UP THE ENGINE IN CLOSED AREAS BECAUSE EXHAUST GASES ARE TOXIC.**

## Precautions

### CAUTION



**NEVER STRESS THE ENGINE AT LOW TEMPERATURES IN ORDER TO AVOID POSSIBLE DAMAGE. BE CAREFUL NEVER TO EXCEED THE MAXIMUM SPEED WHILE RUNNING DOWNHILL, IN ORDER TO AVOID DAMAGING THE ENGINE. IN ANY CASE, IN ORDER TO PRESERVE THE ENGINE FROM PROLONGED OVERREVING, THE REVOLUTION LIMITER WILL BE ACTIVATED IF THE ENGINE SPEED EXCEEDS THE ESTABLISHED THRESHOLD.**

### WARNING



**AFTER A LONG DISTANCE COVERED AT THE MAXIMUM SPEED, DO NOT STOP THE ENGINE IMMEDIATELY, BUT LET IT RUN AT IDLE FOR A FEW SECONDS.**





02\_09

## Stopping the engine (02\_09)

Fully untwist the throttle grip, then rotate the key in the switch «A » to «KEY OFF» (extractable key).

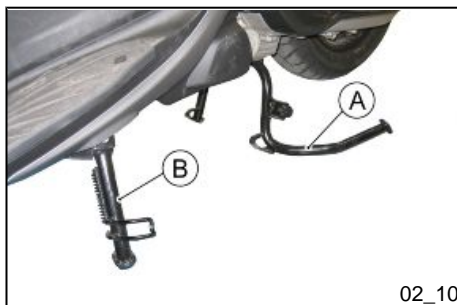

02\_10

## Stand (02\_10)

### Centre stand bracket

Push with your foot on the centre stand's fork "A" while lifting the vehicle backward, using the handlebar.

### Side stand

Push with your foot on the fork of the stand «B» to bring it into open position, while lifting the vehicle at the same time.

### WARNING



**THE SIDE STAND CAUSES THE ENGINE TO TURN ITSELF OFF WHENEVER IT IS LOWERED.**

## TAMPERING MAY CAUSE SERIOUS VEHICLE MALFUNCTION.

### CAUTION



DUE TO THE HIGH TEMPERATURES THE CATALYTIC CONVERTER CAN REACH, ALWAYS TAKE CARE, WHEN PARKING THE VEHICLE, THAT THE EXHAUST DOES NOT COME INTO CONTACT WITH FLAMMABLE MATERIALS, TO AVOID SERIOUS BURNS.

### CAUTION



DO NOT SHUT OFF THE ENGINE WHILE THE VEHICLE IS MOVING. UNBURNED FUEL COULD ENTER THE CATALYTIC CONVERTER AND BURN, CAUSING THE CONVERTER TO OVERHEAT AND POSSIBLY DESTROYING IT.

## Automatic transmission

To ensure simple, pleasurable riding, the vehicle is equipped with automatic transmission with regulator and centrifugal clutch. The system is designed to provide the best performance (acceleration and consumption) while driving on both flat roads and uphill.

If you have to stop on an uphill slope (traffic lights, traffic jam, etc.) **use only the brake to keep the vehicle still, leaving the engine running at idle speed. Using the motor to keep the vehicle still can cause the clutch to overheat.**

It is therefore recommended to avoid conditions of prolonged clutch slippage (other than those previously indicated) such as driving uphill fully laden on steep slopes, or starting off with driver and passenger at slopes greater than 25%.

Take the following precautions if the clutch overheats:

1. Do not continue riding in such conditions.
2. Let the clutch cool down with the engine at idle speed for a few minutes.



### Safe driving (02\_11)

Some simple tips are provided below that will enable you to use your vehicle on a daily basis in greater safety and peace of mind. Your skill and your mechanical knowledge are the basis of a safe ride. We recommend trying out the vehicle in traffic-free zones, in order to acquire a good knowledge of the vehicle itself.

1. Before riding off, remember to put the helmet on and fasten it correctly.
2. Reduce speed on rough roads and ride with care.
3. After riding on a long stretch of wet road without using the brakes, braking can be poor at the beginning. In these conditions, it is a good idea to apply the brakes from time to time.
4. Do not brake hard on wet, unsurfaced or slippery roads.
5. Avoid riding off by mounting the scooter when it is resting on its support. In any case, in order to avoid abrupt departures, the rear wheel should not be turning when it comes into contact with the ground.
6. If the vehicle is used on roads covered with sand, mud, snow mixed with salt, etc., clean the brake disc frequently with a mild detergent in order to prevent abrasive particles from building up inside the holes, which can result in early brake pad wear.

#### CAUTION



**ALWAYS RIDE WITHIN YOUR LIMITS RIDING UNDER THE INFLUENCE OF ALCOHOL OR OTHER DRUGS AND CERTAIN MEDICINES IS EXTREMELY DANGEROUS.**

**CAUTION**

**IN ORDER TO PREVENT ANY ACCIDENTS RIDE VERY CAREFULLY AFTER ADDING ACCESSORIES AND WHILE CARRYING LUGGAGE. ADDING ACCESSORIES AND LUGGAGE CAN REDUCE THE VEHICLE'S STABILITY, PERFORMANCE AND SAFETY DURING USE.**



**NEVER RIDE THE VEHICLE EQUIPPED WITH ACCESSORIES (PANNIERS, TOP BOX AND/OR WINDSHIELD) AT A SPEED HIGHER THAN 110 km/h.**

**THE VEHICLE CAN BE RIDDEN AT A HIGHER SPEED WITHOUT THE ACCESSORIES MENTIONED BEFORE WITHIN THE LIMITS ESTABLISHED BY LAW.**

**IF THERE ARE ANY NON-PIAGGIO ACCESSORIES INSTALLED, OR AN ABNORMAL LOAD, OR IF THE SCOOTER IS NOT IN A GENERALLY GOOD CONDITION, OR WHENEVER WEATHER CONDITIONS DEMAND IT, SPEED SHOULD BE FURTHER REDUCED.**

**CAUTION**

**DO NOT ADJUST THE MIRRORS WHILE RIDING. THIS COULD CAUSE YOU TO LOOSE CONTROL OF THE VEHICLE.**

**CAUTION**

**ANY ELABORATION THAT MODIFIES THE VEHICLE'S PERFORMANCES, SUCH AS TAMPERING WITH ORIGINAL STRUCTURAL PARTS IS STRICTLY FORBIDDEN BY LAW, AND RENDERS THE VEHICLE NO LONGER CONFORMING TO THE APPROVED TYPE AND DANGEROUS FOR RIDING.**





# LUM Beverly Sport Touring ABS- ASR



**PIAGGIO®**



**Chap. 03  
Maintenance**

## Engine oil level

In 4-stroke engines, engine oil is used to lubricate the distribution elements, the bushes and the thermal group. **An insufficient quantity of oil can cause serious damage to the engine.** In all four-stroke engines, a loss of efficiency in oil performance and certain consumption should be considered normal. Consumption can particularly reflect the conditions of use (i.e. when driving at 'full acceleration' all the time, oil consumption increases). The replacement intervals provided for by the maintenance programme are defined depending on the total content of oil in the engine and the average consumption measured following standardised methods.

**In order to prevent any problems, we recommend checking oil level more frequently than indicated in the Scheduled Maintenance table or before setting off on long journeys. The scooter is, however, equipped with an oil pressure warning light on the instrument panel.**



### Engine oil level check (03\_01, 03\_02)

Every time the vehicle is used, visually inspect the level of the engine oil when the engine is cold (after **completely unscrewing** the oil cap/dipstick). The oil level should be somewhere between the MAX and MIN index marks on the level rod; «A»; while the oil is being checked, the vehicle must be resting on its centre stand on an even, horizontal surface.

If the check is carried out after the vehicle has been used, and therefore with a hot engine, the level will be lower; in order to carry out a correct check, wait at least 10 minutes after the engine has been stopped so as to get the correct level.



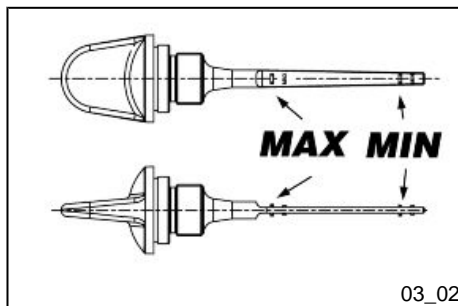

03\_02

### Engine oil top-up (03\_03)

The oil should be topped up after having checked the level and in any case by adding oil **without ever exceeding the MAX. level**. The recovery level between the **MIN** and **MAX** level entails a quantity of oil of approx. 600 cm<sup>3</sup>.

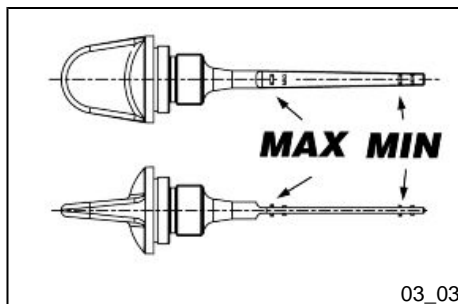

03\_03

### Warning light (insufficient oil pressure) (03\_04)

The vehicle is equipped with a warning light that comes on when the key is turned to «ON». However, this light should switch off once the engine has been started. **If the light comes on while braking, at idle speed or while turning a corner, it is necessary to check the oil level and top it up if required.** If after having topped-up the oil, the warning light still comes on while braking, at idle speed or while turning a corner, it will be necessary to take your vehicle to an Authorised Service Centre.

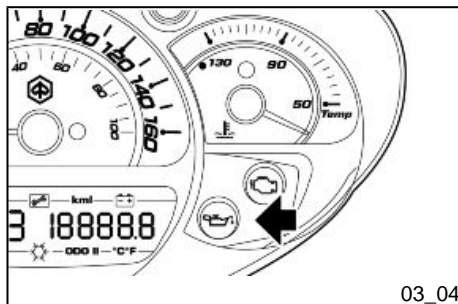

03\_04

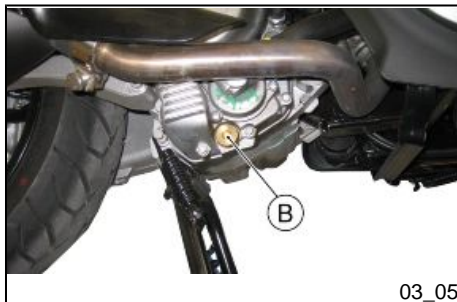

03\_05

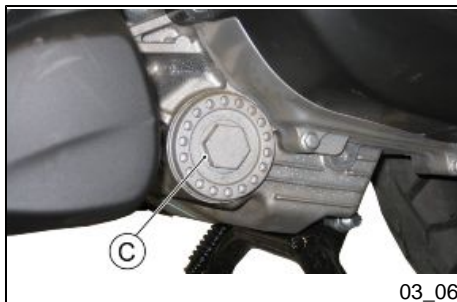

03\_06



03\_07

## Engine oil change (03\_05, 03\_06, 03\_07, 03\_08)

Have oil changed and cartridge filter «C» replaced as indicated in the scheduled maintenance table at an **Authorised Service Centre**. Empty the engine by draining the oil through drainage cap «C». In order to facilitate oil drainage, loosen the cap/dipstick. Since a certain quantity of oil still remains in the circuit, add approx. 1100 to 1200 cm<sup>3</sup> of oil through the cap «A». Then start the engine, leave it running for a few minutes and shut it off: after 10 minutes check the level and, if necessary top it up **without exceeding the MAX level**. The cartridge filter must be replaced every time the oil is changed. For top-ups and changes, use new oil of the recommended type.

### WARNING



**CHECK THE STATE OF THE SEALING O-RING AND IF DAMAGED, REPLACE WITH A NEW ONE.**

**THE ASSEMBLY, BE CAREFUL TO OIL IT SLIGHTLY.**

### WARNING



**RUNNING THE ENGINE WITH INSUFFICIENT LUBRICATION OR WITH INADEQUATE LUBRICANTS ACCELERATES THE WEAR AND TEAR OF THE MOVING PARTS AND CAN CAUSE IRRETRIEVABLE DAMAGE.**

### WARNING



**EXCESSIVE OIL LEVEL AT TOP-UPS CAN LEAD TO SCALE FORMATION AND VEHICLE MALFUNCTION.**

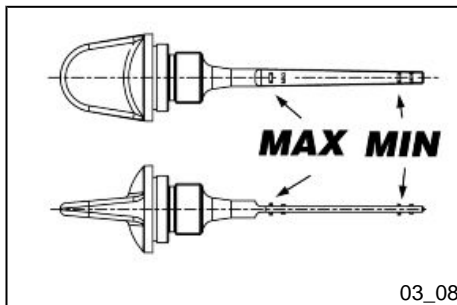

03\_08

**CAUTION**

USED OILS CONTAIN SUBSTANCES HARMFUL TO THE ENVIRONMENT. FOR OIL CHANGE, CONTACT AN AUTHORISED SERVICE CENTRE WHICH IS EQUIPPED TO DISPOSE OF USED OILS IN AN ENVIRONMENTALLY FRIENDLY AND LEGAL WAY.

**CAUTION**

USING OILS OTHER THAN THOSE RECOMMENDED CAN SHORTEN THE LIFE OF THE ENGINE.

**Recommended products**

eni i-Ride scooter 15W-50

*Synthetic-based lubricant for four stroke engines.*

JASO MA, MA2 - API SJ - ACEA A3

**Hub oil level (03\_09)**

Check the oil in the rear hub. To check the rear hub oil level, proceed as follows:

1. Rest the vehicle onto its centre stand, on level ground.
2. Unscrew the screw «A» and if oil comes out or touches the screw hole the level is correct. Otherwise, top up the oil.
3. Screw the screw back in, checking that it is locked in place.

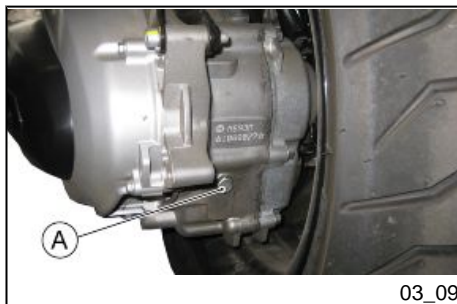

03\_09

**CAUTION**

**RIDING THE VEHICLE WITH INSUFFICIENT HUB LUBRICATION OR WITH CONTAMINATED OR IMPROPER LUBRICANTS ACCELERATES THE WEAR AND TEAR OF THE MOVING PARTS AND CAN CAUSE SERIOUS DAMAGE.**

**CAUTION**

**USED OIL CAN HARM THE ENVIRONMENT. COLLECTION AND DISPOSAL SHOULD BE CARRIED OUT IN COMPLIANCE WITH REGULATIONS IN FORCE.**

**CAUTION**

**UPON REPLACING HUB OIL, AVOID THE OIL COMING INTO CONTACT WITH THE REAR WHEEL AND TYRE.**

**CAUTION**

**FOR OIL REPLACEMENT, CONTACT ANY AUTHORISED SERVICE CENTRE AS THEY ARE EQUIPPED TO DISPOSE OF USED OILS IN AN ENVIRONMENTALLY FRIENDLY AND LEGAL WAY.**

**Recommended products**

**AGIP GEAR SAE 80W-90**

*Lubricant for gearboxes and transmissions.*

API GL-4

## Characteristic

### Transmission oil

About 500 cc

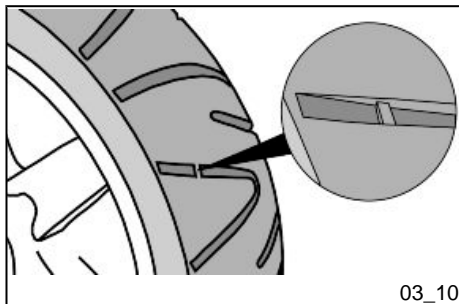

### Tyres (03\_10)

Check tyre pressure and wear periodically as indicated in the scheduled maintenance table. Tyres feature wear indicators; replace tyres as soon as these indicators become visible on the tyre tread. Also check that the tyres do not show signs of splitting at the sides or irregular tread wear; if this occurs, go to an authorised workshop or at least to a workshop equipped to replace tyres.

#### CAUTION



**TYRE PRESSURE SHOULD BE CHECKED WHEN TYRES ARE COLD. INCORRECT TYRE PRESSURE CAUSES ABNORMAL TYRE WEAR AND MAKES RIDING DANGEROUS.**

**TYRES MUST BE REPLACED WHEN THE TREAD REACHES THE WEAR LIMITS SET FORTH BY LAW.**

#### WARNING



**THE WHEELS FITTED WITH TYRES SHOULD ALWAYS BE BALANCED. RIDING THE VEHICLE WITH VERY LOW TYRE PRESSURE OR WITH INCORRECTLY BALANCED TYRES CAN LEAD TO DANGEROUS STEERING VIBRATIONS.**

## TYRES

Front tyre	110/70 - 16" M/C 52S Tubeless
Rear tyre	150/70 - 14" M/C 66S Tubeless

## TYRE INFLATION PRESSURE

Front tyre pressure (with passenger)	2.2 bar (2.2 bar)
Rear tyre pressure (with passenger)	2.4 bar (2.6 bar)



### **Spark plug dismantlement (03\_11, 03\_12)**

Proceed as follows:

- Remove the case that grants access to the spark plug located on the right side fairing by unscrewing the indicated screw.
- Disconnect spark plug HV wire cap «A».
- Unscrew the spark plug using the wrench supplied.
- When refitting, place the spark plug into the hole at the corresponding angle and finger tighten it as far as it will go. Use the wrench only to tighten it.
- Place cap «A» fully over the spark plug.



03\_12

**WARNING**

**SPARK PLUG MUST BE REMOVED WHEN THE ENGINE IS COLD. REPLACE THE SPARK PLUG AS INDICATED IN THE SCHEDULED MAINTENANCE TABLE. USE OF SPARK PLUGS OTHER THAN THE INDICATED TYPE CAN SERIOUSLY DAMAGE THE ENGINE.**

**N.B.**

**USING SPARK PLUGS OTHER THAN THE INDICATED TYPE OR SHIELDLESS SPARK PLUG CAPS CAN CAUSE ELECTRICAL SYSTEM FAILURES.**

**Characteristic**

**Spark plug**

NGK CR7EKB



03\_13

**Removing the air filter (03\_13)**

To reach the air filter:

- Undo the seven screws «A» and remove the air filter cover.



03\_14

### Air filter cleaning (03\_14, 03\_15, 03\_16, 03\_17)

1. Blow with compressed air from the white cotton side.
2. Wash with mild soap and water, without bending or twisting the filter, then dry with compressed air.
3. Soak in a solution of 50% unleaded petrol and specified oil, using a brush.

#### CAUTION



**IF THE VEHICLE IS USED ON DUSTY ROADS IT IS NECESSARY TO CARRY OUT MAINTENANCE CHECKS OF THE AIR FILTER MORE OFTEN TO AVOID DAMAGING THE ENGINE.**

#### Recommended products

##### AGIP FILTER OIL

*Special product for the treatment of foam filters.*

-



03\_15

4. Check the lower part of the bleed cap for dirt.



**REMOVE ANY DEPOSIT THAT MAY HAVE FORMED IN THE BLEED PIPE, COMING FROM THE FILTER BOX. PROCEED AS FOLLOWS:**

1. remove the cap;
2. discharge the contents into a container and send it to a recycling bank.





03\_16

5. Working from the right side of the vehicle, unscrew the two indicated screws and remove the plastic cover.



03\_17

6. Remove the clamp to allow the removal of the cap to check for the presence of oil due to condensation of vapours.



**REMOVE ANY DEPOSIT THAT MAY HAVE FORMED IN THE BLEED PIPE, COMING FROM THE FILTER BOX. PROCEED AS FOLLOWS:**

1. remove the cap;
2. discharge the contents into a container and send it to a recycling bank.

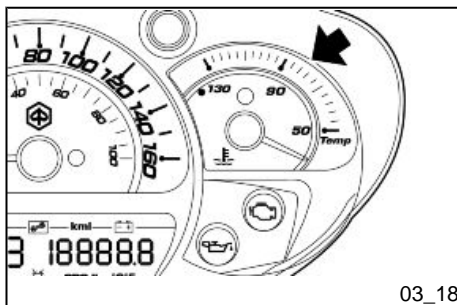

03\_18

### Cooling fluid level (03\_18, 03\_19, 03\_20, 03\_21)

Engine cooling is carried out by a forced-circulation coolant system. The coolant consists of a mixture 50% de-ionised water and 50% glycol ethylene-based antifreeze solution with corrosion inhibitors. The coolant supplied with the scooter is already mixed and ready for use.

For the proper functioning of the engine, it is necessary for the coolant temperature to be maintained at about 90 ° C. If the needle of the gauge enters the red zone, stop the engine, let it cool down and check the coolant level; if the level is OK, contact an **Authorised Service Centre**.



03\_19



03\_20

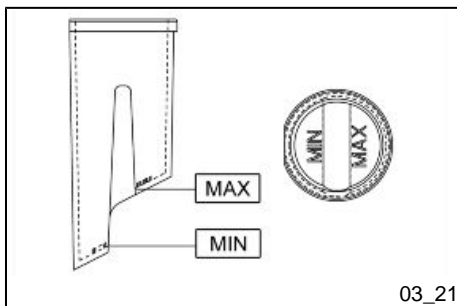

03\_21

Check coolant when the engine is cold and as indicated in the scheduled maintenance tables, following the steps below.

1. Set the vehicle upright on the stand and remove the cover by undoing screw «A».
2. Remove the expansion tank cap «B» by turning it anticlockwise.
3. Look inside the expansion tank and check that fluid level is always between the «MIN» and «MAX» levels.
4. Top-up the fluid when it is close to the minimum mark.

If the level is not correct, proceed to top-up when the engine is cold. If the coolant needs to be topped up frequently or the expansion tank is completely dry, check the cooling system to find the cause of the problem. It is therefore essential to have the cooling system checked at an **Authorised Service Centre**.

Replace coolant as indicated in the scheduled maintenance table. Take your vehicle to an **Authorised Service Centre** for this operation.

#### WARNING



**TO AVOID THE RISK OF SCALDING, DO NOT UNSCREW THE EXPANSION TANK COVER WHILE THE ENGINE IS STILL HOT.**

#### WARNING



**IN ORDER TO AVOID HARMFUL FLUID LEAKS WHILE RIDING, IT IS IMPORTANT TO MAKE SURE THAT THE LEVEL DOES NOT EXCEED THE REFERENCE TONGUE TOO MUCH.**

**TO ENSURE CORRECT ENGINE OPERATION, KEEP THE RADIATOR GRILLE CLEAN.**

#### Recommended products

**AGIP PERMANENT SPECIAL**

Ethylene glycol-based antifreeze fluid with organic inhibition additives. Red, ready to use.

ASTM D 3306 - ASTM D 4656 - ASTM D 4985 - CUNA NC 956-16

### Checking the brake oil level (03\_22)

The front and rear brake fluid reservoirs are both positioned on the handlebar. Proceed as follows:

- Rest the vehicle on its centre stand with the handlebars perfectly horizontal;
- Check the fluid level through the sight glass «A».

A drop in the brake fuel level may be caused by pad wear. Should the level appear to be below the minimum mark, please contact an **Authorised Service Centre or Dealer** in order to have a thorough inspection of the braking system carried out.



03\_22

### Braking system fluid top up (03\_23, 03\_24, 03\_25, 03\_26, 03\_27, 03\_28, 03\_29, 03\_30, 03\_31, 03\_32, 03\_33)

For topping-up, proceed as follows:

- Undo the three screws «A» and remove the windshield
- Loosen screw «B», slide the windshield support and rubber protection upwards
- Remove the mirrors unscrewing them from their seats
- Undo the two screws «C» and remove the pressure covering.
- Undo the two screws «D» and working from both sides of the vehicle, undo screw «E».
- Using a flat-headed screwdriver, detach the fastener tab as shown in the figure, accessing the tab via the indicated slit.



03\_23

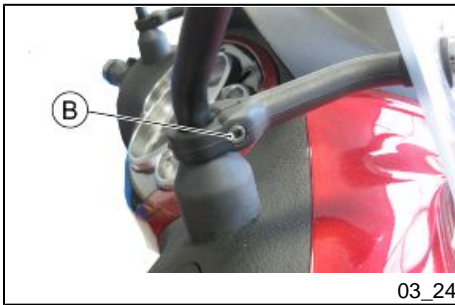

- Insert the screwdriver between the two covers, as indicated in the figure, and detach the upper fastener tab. Move the rear handlebar cover aside.

- Undo the two screws «F» and remove the front handlebar cover, by disengaging the front headlamp unit connector

- Undo the two screws «G» and remove the cap«H» of the brake pump to restore the optimal level

#### WARNING

**BRAKING CIRCUIT FLUID IS HIGHLY CORROSIVE; MAKE SURE THAT IT DOES NOT COME INTO CONTACT WITH THE PAINTWORK.**

#### CAUTION

**ONLY USE DOT 4-CLASSIFIED BRAKE FLUID.**

#### WARNING

**THE BRAKE FLUID IS HAZARDOUS: IN CASE OF ACCIDENTAL CONTACT, WASH OFF WITH WATER.**

#### WARNING

**THE BRAKING CIRCUIT LIQUID IS HYGROSCOPIC, AND ABSORBS THE HUMIDITY OF SURROUNDING AIR. IF THE HUMIDITY IN THE BRAKING FLUID EXCEEDS A CERTAIN VALUE, IT WILL LEAD TO INEFFICIENT BRAKING. NEVER USE BRAKING FLUID KEPT IN CONTAINERS THAT HAVE ALREADY BEEN OPENED, OR PARTIALLY USED.**

### Recommended products

#### Brake fluid

*Brake fluid.*

Synthetic fluid SAE J 1703 -FMVSS 116 - DOT 3/4 - ISO 4925 - CUNA NC 956 DOT 4



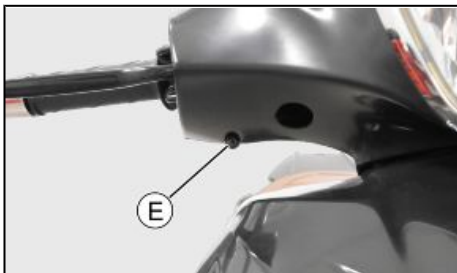

03\_27



03\_28

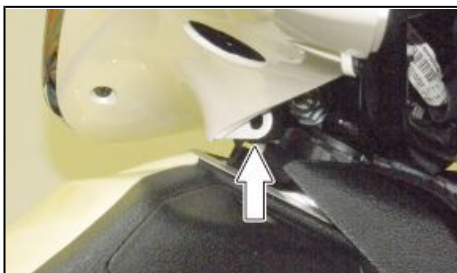

03\_29



03\_30

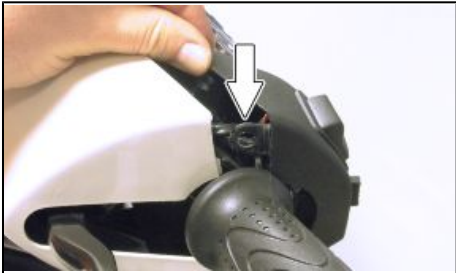

03\_31

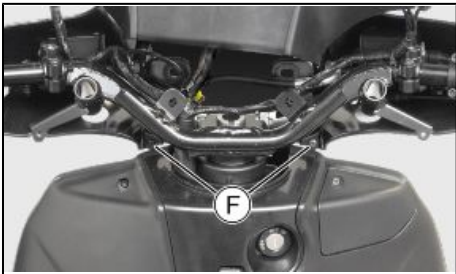

03\_32

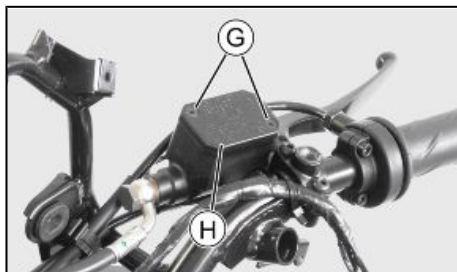

03\_33



03\_34



03\_35

### Battery (03\_34, 03\_35, 03\_36, 03\_37)

To access the battery, proceed as follows:

- Position the vehicle on centre stand
- Open the saddle according to that described in the related section
- Exerting a light pressure on the indicated fitting, remove the cover of the toolkit compartment and the tools underneath
- Unscrew the three screws «A» and remove the cover «B»

The battery is the electrical device that requires the most frequent inspections and diligent maintenance.

The main points of maintenance to be observed are as follows:

#### WARNING



**DO NOT DISCONNECT THE BATTERY CABLES WITH THE ENGINE RUNNING, THIS CAN CAUSE IRREPARABLE DAMAGE TO THE VEHICLE'S ELECTRONIC CONTROL UNIT.**



03\_36

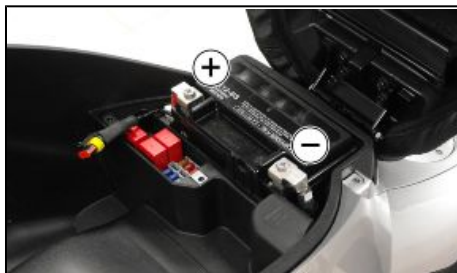

03\_37

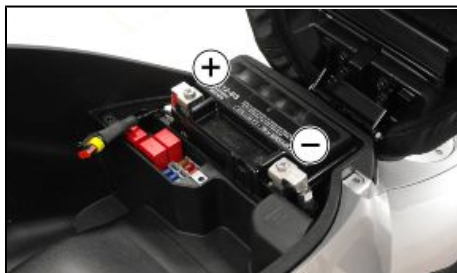

03\_38

**WARNING**

USED BATTERIES ARE HARMFUL FOR THE ENVIRONMENT. COLLECTION AND DISPOSAL SHOULD BE CARRIED OUT IN COMPLIANCE WITH REGULATIONS IN FORCE.

**Characteristic****Battery**

SEALED 12V/10Ah

**Use of a new battery (03\_38)**

Ensure that the terminals are connected correctly and check the voltage.

**CAUTION**

**DO NOT REVERSE THE POLARITY: RISK OF SHORT CIRCUIT AND DAMAGE TO THE ELECTRICAL SYSTEM.**



## Long periods of inactivity

Battery performance will decrease if the vehicle is not used for a long time. This is the result of the natural phenomenon of battery discharging, and may be due to residual absorption by vehicle components with constant power consumption. Poor battery performance may also be due to environmental conditions and the cleanliness of the poles. In order to avoid difficult starts and/or irreversible damage to the battery, follow any of these steps:

- **At least once a month** start the engine and run it slightly above idle speed for 10-15 minutes. This keeps all the engine components, as well as the battery, in good working order.

- Take your vehicle to a garage (as indicated in the «Vehicle not used for extended periods» section) to have the battery removed. Have the battery cleaned, charged fully and stored in a dry, ventilated place. Recharge **at least once every two months**.

### CAUTION

**THE BATTERY MUST BE RECHARGED WITH A CURRENT LOAD EQUAL TO 1/10 OF THE BATTERY RATED CAPACITY AND FOR A PERIOD NOT LONGER THAN 8 HOURS. TAKE THE VEHICLE TO AN AUTHORISED PIAGGIO SERVICE CENTRE FOR THIS OPERATION. WHEN REFITTING THE BATTERY MAKE SURE THE LEADS ARE CORRECTLY CONNECTED TO THE TERMINALS.**



03\_39

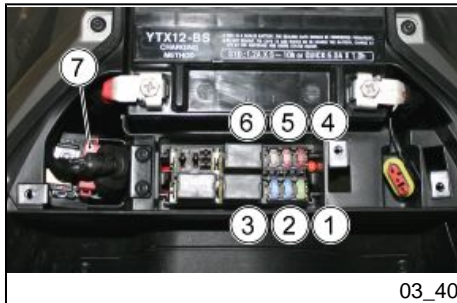

03\_40

## Fuses (03\_39, 03\_40)

The electrical system is equipped with 6 protection fuses located below the saddle. Open the saddle and, as described above, remove the tools.

Unscrew the three screws «A» and remove the cover «B»

The chart shows the position and specifications of the fuses in the vehicle.

### CAUTION



**BEFORE REPLACING A BLOWN FUSE, FIND AND SOLVE THE FAILURE THAT CAUSED IT TO BLOW. NEVER TRY TO REPLACE A FUSE WITH ANY OTHER MATERIAL (A PIECE OF ELECTRIC WIRE, FOR INSTANCE).**

### CAUTION



**MODIFICATIONS OR REPAIRS TO THE ELECTRICAL SYSTEM, PERFORMED INCORRECTLY OR WITHOUT STRICT ATTENTION TO THE TECHNICAL SPECIFICATIONS OF THE SYSTEM CAN CAUSE MALFUNCTIONING AND RISK OF FIRE.**

## FUSES

Fuse No. 1

**Capacity:** 20 A

**Protected circuits:** battery-powered: ABS control unit

Fuse No. 2

**Capacity:** 15 A

**Protected circuits:** battery-powered: antitheft pre-installation, saddle release control unit pre-installation, electric fan relay (contact)

Fuse No. 3

**Capacity:**10 A

**Protected circuits:**electronic control unit, injection load solenoid, (contact)

Fuse No. 4

**Capacity:** 15 A

**Protected circuits:** battery-powered headlight relay (contact), instrument panel, battery-powered LV socket, helmet compartment bulb, key powered saddle release actuator

Fuse No. 5

**Capacity:** 10 A

**Protected circuits:** key powered: antitheft pre-installation, saddle release control unit pre-installation, turn indicator control device, high-beam flash, instrument panel, daylight running lights, horn, stop lights, start-up enabling switch, license plate light

Fuse No. 6

**Capacity:** 5 A

**Protected circuits:** Protected circuits: live power: headlight relay (coil), immobilizer antenna, electronic control unit, injection

load relay (coil), ABS control unit and ASR warning light.

Fuse No. 7

**Capacity:** 30 A

**Protected circuits:** general, recharge battery

**Live:** fuses No. 5 and 6

## Lamps

### BULBS

Low beam light bulb

**Type:** Halogen H7

**Quantity:** 1

**Power:** 12V - 55W

High beam light bulb

**Type:** Halogen H7

**Quantity:** 1

**Power:** 12V - 55W

Front tail light bulb

**Type:** LED

**Quantity:** -

**Power:** -

Front turn indicator light bulb

**Type:** Spherical BAU 15s

**Quantity:** 1 Right - 1 Left

**Power:** 12V - 10W

Stop light/rear daylight running  
light bulb

**Type:** LED

**Quantity:** -

**Power:** -

Rear turn indicator light bulb

**Type:** Spherical BAU 15s

**Quantity:** 1 Right - 1 Left

**Power:** 12V - 10W

License plate light bulb

**Type:** All glass W5W

**Quantity:** 1

**Power:** 12V - 5W

Helmet compartment light bulb

**Type:** Cylindrical C5W

**Quantity:** 1

**Power:** 12V - 5W

Instrument panel lighting bulb

**Type:** LED

**Quantity:** 4

**Power:** -



03\_41



03\_42

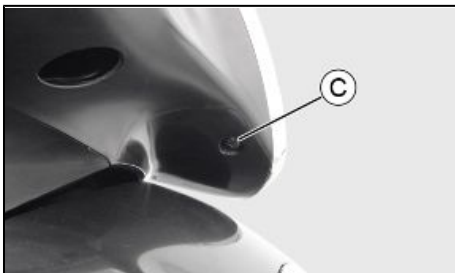

03\_43

### Front light group (03\_41, 03\_42, 03\_43, 03\_44)

To remove the front headlight assembly the windshield does not need to be removed.  
To remove the front headlight assembly, proceed as follows:

- Unscrew the two screws «A» and remove the pressure covering
- Unscrew the two upper screws «E» fastening the headlight assembly
- Working on both sides of the vehicle, unscrew the lower fixing screws «C» and remove the headlight. Remove the rubber protection.

This gives access to the bulbs.

To replace the low-beam light act on the lamp holder«D». To replace the high-beam light act on the lamp holder«E» unhooking the relevant pin.

To reassemble, repeat the operation but in reverse order.

#### WARNING



**HIGH- AND LOW-BEAM BULBS ARE HALOGEN TYPE: DO NOT TOUCH THEM WITH YOUR FINGERS TO AVOID DAMAGING THEIR FUNCTION.**

#### CAUTION



**DO NOT PLACE, TRANSPORT OBJECTS AND/OR CLOTHES OVER THE FRONT HEADLIGHT ASSEMBLY, WHEN THE HEADLIGHT IS TURNED ON OR OFF. FAILURE TO FOLLOW THIS PRECAUTION MAY CAUSE OVERHEATING AND THE SUBSEQUENT FUSION OF THE GLASS.**

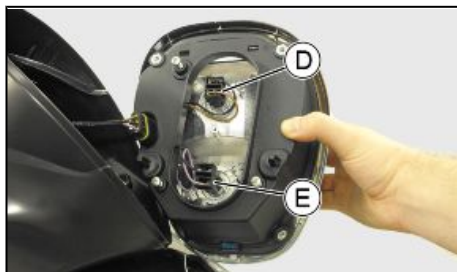

03\_44

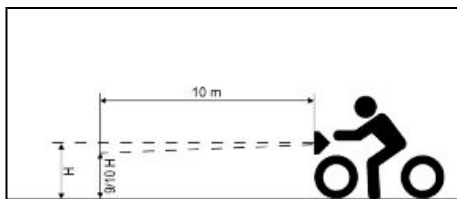

03\_45



03\_46

### Headlight adjustment (03\_45, 03\_46, 03\_47)

Proceed as follows:

- Position the vehicle in running order and with the tyres inflated to the prescribed pressure, onto a flat surface, 10 m away from a half-lit white screen; ensure that the longitudinal axis of the vehicle is perpendicular to the screen;
- Turn on the headlight and check that the borderline of the projected light beam on the screen is not higher than 9/10 or lower than 7/10 of the distance from the ground to the centre of the vehicle headlamp;
- Otherwise, adjust the headlight. For this operation it is not necessary to remove the windshield. Unscrew the two screws «A» and remove the pressure covering. Screw in the screw «B» to lower the light beam, unscrew the screw «B» to raise the light beam.

#### N.B.

**THE ABOVE PROCEDURE COMPLIES WITH THE EUROPEAN STANDARDS REGARDING MAXIMUM AND MINIMUM HEIGHT OF LIGHT BEAMS. REFER TO THE STATUTORY REGULATIONS IN FORCE IN EVERY COUNTRY WHERE THE VEHICLE IS USED.**

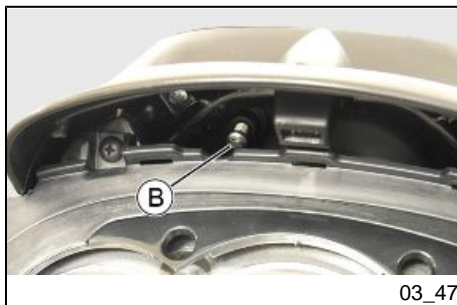

03\_47



03\_48



03\_49

### Front direction indicators (03\_48, 03\_49, 03\_50)

To replace the indicator bulbs proceed as follows:

- Open the front case
- Remove the rubber protection
- Remove the lamp holder, rotating it towards the inside of the vehicle
- Lightly press the lamp and turn it anticlockwise and remove it.

#### WARNING



**THE DAYLIGHT RUNNING LIGHTS PRESENT IN THE SAME GROUP ARE «LED» TYPES. IN CASE OF MALFUNCTIONING, AS THE REMOVAL IS PARTICULARLY DIFFICULT, WE ADVISE ADDRESSING AN Authorised PIAGGIO Service Centre FOR THE REPLACEMENT.**





03\_50



03\_51



03\_52

### Rear optical unit (03\_51, 03\_52, 03\_53)

To replace the indicator bulbs proceed as follows:

- Open the saddle
- Remove the rubber protection
- Remove the lamp holder turning it towards the base
- Lightly press the lamp and turn it anticlockwise and remove it.

#### WARNING



**THE DAYLIGHT RUNNING LIGHTS PRESENT IN THE SAME GROUP ARE «LED» TYPES. IN CASE OF MALFUNCTIONING, AS THE REMOVAL IS PARTICULARLY DIFFICULT, WE ADVISE ADDRESSING AN Authorised PIAGGIO Service Centre FOR THE REPLACEMENT.**

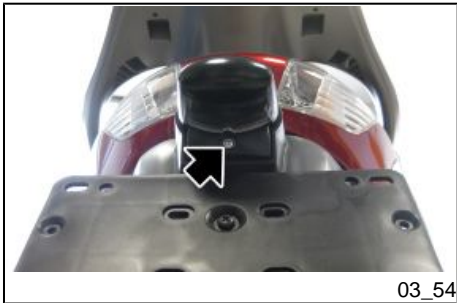

### Number plate light (03\_54)

Unscrew the indicated screw and then take out the lamp holder.

#### CAUTION



**DO NOT PULL THE ELECTRICAL WIRING TO EXTRACT THE BULB HOLDER.**

### Helmet compartment lighting bulb (03\_55)

Open the helmet compartment, take out the snap-on transparent glass and replace the bulb.



03\_55

### Rear-view mirrors (03\_56)

Adjust the mirrors by applying slight pressure to the side of the mirror to move it to the desired position.



03\_56



03\_57

## Front and rear disc brake (03\_57)

The brake disc and pad wear is automatically compensated, therefore it has no effect on the functioning of the front and rear brakes. For this reason it is not necessary to adjust the brakes. An excessively elastic brake lever stroke may indicate the presence of air in the braking circuit or a failure in the braking system. In this case, mainly due to the importance of brakes to guarantee safe riding conditions, the vehicle should be taken to an **Authorised Service Centre or Dealer**.

### CAUTION



**BRAKING SHOULD BEGIN AFTER ABOUT 1/3 OF THE BRAKE LEVER STROKE.**

**IN CASE OF EXCESSIVE TRAVEL, CHECK THE PROPER OPERATION OF THE BRAKE SYSTEM AT AN AUTHORISED SERVICE CENTRE.**

### CAUTION



**HAVE THE BRAKE PADS CHECKED BY THE DEALER ACCORDING TO THE CHECKS SPECIFIED IN THE SCHEDULED MAINTENANCE TABLE. HOWEVER, IN THE EVENT OF NOISES COMING FROM THE FRONT AND/OR REAR BRAKING SYSTEM DURING OPERATION, IT IS ADVISABLE TO HAVE THE BRAKING SYSTEM CHECKED BY AN AUTHORISED SERVICE CENTRE OR DEALER. AFTER REPLACING THE BRAKE PADS, DO NOT USE THE SCOOTER UNTIL YOU HAVE OPERATED THE BRAKE LEVER SEVERAL TIMES IN ORDER TO ALLOW THE PLUNGERS TO SETTLE AND THE LEVER STROKE TO BE SET TO THE CORRECT POSITION.**

### CAUTION



**THE PRESENCE OF SAND, MUD, SNOW MIXED WITH SALT, ETC. ON THE ROAD, CAN DRASTICALLY REDUCE THE LIFE OF THE BRAKE PADS. WHEN RIDING THE VEHICLE ON ROADS WITH THE ABOVE MENTIONED CHARAC-**

**TERISTICS, WE RECOMMEND TO CLEAN THE BRAKE DISC FREQUENTLY WITH A NON-AGGRESSIVE DETERGENT IN ORDER TO AVOID THE FORMATION OF ABRASIVE BUILD-UPS IN THE HOLES, WHICH COULD RESULT IN EARLY WEAR OF BRAKE PADS.**

## **Puncture**

The vehicle is equipped with Tubeless tyres (without inner tube). In the event of a puncture, Tubeless tyres - unlike tyres with inner tubes - go flat very slowly, resulting in a greater steering safety. In the event of a puncture, an emergency repair can be carried out using an "inflate and repair" spray can. For a final repair, take your vehicle to an **Authorised Service Centre or Dealer**. The replacement of a tyre involves removing the wheel in question. Take your vehicle to an **Authorised Service Centre or Dealer** for these operations.

### **CAUTION**



**TO USE THE "INFLATE AND REPAIR" SPRAY CAN PROPERLY, FOLLOW THE INSTRUCTIONS ON THE PACKAGING.**

### **WARNING**



**THE WHEELS FITTED WITH TYRES SHOULD ALWAYS BE BALANCED. RIDING THE VEHICLE WITH VERY LOW TYRE PRESSURE OR WITH INCORRECTLY BALANCED TYRES CAN LEAD TO DANGEROUS STEERING VIBRATIONS.**

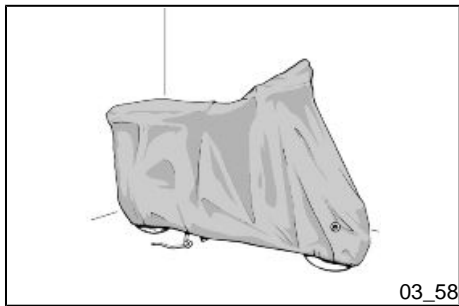

03\_58

## Periods of inactivity (03\_58)

The following operations are recommended:

1. Clean the scooter thoroughly and then cover it with a canvas;
2. With the engine off and the piston at the bottom dead centre position, remove the spark plug, and pour  $1 \div 2 \text{ cm}^3$  of the recommended oil through its hole. Operate the starter button 1-2 times for roughly 1 second to turn the engine over slowly, then insert the spark plug again;
3. Ensure that the **fuel tank is at least half full (so that the fuel pump is fully covered)**; spread antirust grease on the uncoated metal parts; keep the wheels lifted above the ground by resting the chassis on two wooden wedges;
4. As regards the battery, follow the instructions in the «Battery» section.

## Recommended products

### eni i-Ride PG 5W-40

*Synthetic based lubricant for high-performance four-stroke engines.*  
 JASO MA, MA2 - API SL - ACEA A3

## Cleaning the vehicle

Use a low pressure jet of water to soften the caked dirt and mud deposited on the painted surfaces. Once softened, sponge off mud and dirt using a car body sponge soaked in a car body shampoo and water solution (2-4% of car shampoo in water). Then rinse with abundant water, and dry with a shammy cloth. For the engine exterior, use petrol, a brush and clean cloths. Petrol can damage paintwork. Remember that any polishing with silicone wax must always be preceded by washing.

**CAUTION**

**DETERGENTS CAN POLLUTE WATER. THE VEHICLE MUST BE WASHED AT A WASH STATION EQUIPPED WITH A SPECIAL WATER PURIFICATION SYSTEM.**

**CAUTION**

**DO NOT USE A HIGH-PRESSURE WATER JET MACHINE TO CLEAN THE ENGINE AND/OR VEHICLE; HOWEVER, IF NO OTHER MEANS ARE AVAILABLE, IT IS THEN NECESSARY TO:**

- **ONLY USE A FANLIKE SPRAY JET.**
- **DO NOT PLACE THE NOZZLE CLOSER THAN 60 CM.**
- **DO NOT USE WATER AT TEMPERATURES OVER 40°C.**
- **DO NOT USE HIGH-PRESSURE WATER JETS.**
- **DO NOT STEAM WASH.**
- **DO NOT AIM THE JET AT: THE ENGINE, THE WIRING, THE COOLING SLITS ON THE TRANSMISSION OR SCROLL COVERS.**

**CAUTION**

**NEVER WASH THE SCOOTER IN DIRECT SUNLIGHT, ESPECIALLY IN SUMMER WHEN THE BODYWORK IS STILL HOT AS THE SHAMPOO COULD DAMAGE THE PAINTWORK IF IT DRIES BEFORE BEING RINSED OFF. NEVER USE CLOTHS SOAKED IN ALCOHOL, PETROL, DIESEL OIL OR KEROSENE FOR CLEANING THE PAINTED OR PLASTIC SURFACES, IN ORDER NOT TO DAMAGE THE LUSTRE FINISH OR ALTER THEIR MECHANICAL PROPERTIES. USING SILICONE-BASED WAX CAN DAMAGE THE PAINTED SURFACES, DEPENDING ON THE VEHICLE COLOUR (SATIN COLOURS). FOR FURTHER**

INFORMATION ON THIS MATTER, CONTACT AN AUTHORISED SERVICE CENTRE.

**WARNING**



CLEAN YOUR SCOOTER FREQUENTLY SO AS TO AVOID POSSIBLE DIRT OR MUD DEPOSITS THAT COULD CAUSE MALFUNCTIONING IN THE THROTTLE GRIP TRANSMISSION AND/OR OTHER COMPONENTS.

## Troubleshooting

### STARTING FAILURE

Emergency switch in «OFF»	Set the switch back to «ON»
Fuse blown	Replace the blown fuse and have the vehicle checked by an <b>Authorised Service Centre</b> .

### DIFFICULTY STARTING

Lack of fuel in tank.	Refuelling
Injection system fault	Contact an <b>Authorised Service Centre</b>



Fuel pump fault	Contact an <b>Authorised Service Centre</b>
Flat battery	Recharge the battery.

***\* IMPORTANT: DO NOT USE THE SCOOTER TO THE COMPLETE EXHAUSTION OF FUEL; SHOULD THIS OCCUR, DO NOT ATTEMPT TO START THE ENGINE. TURN THE IGNITION KEY TO «OFF» AND TOP-UP THE FUEL TANK AS SOON AS POSSIBLE. FAILURE TO FOLLOW THESE GUIDELINES COULD DAMAGE THE FUEL PUMP AND/OR THE CATALYTIC CONVERTER.***

### **IGNITION PROBLEMS**

Faulty spark plug	Contact an <b>Authorised Service Centre.</b>
Faulty ignition / injection control unit. Due to the presence of high voltage, this check should only be carried out by an expert.	Contact an <b>Authorised Service Centre</b>

### **LACK OF COMPRESSION**

Loose spark plug.	Screw in the spark plug tightly
Cylinder head loose, piston gas rings worn.	Contact an <b>Authorised Service Centre.</b>
Valve stuck	Contact an <b>Authorised Service Centre.</b>

## **HIGH CONSUMPTION AND LOW PERFORMANCE**

Air filter blocked or dirty.

Clean or replace.

## **INSUFFICIENT BRAKING**

Greasy disc. Worn pads. Faulty braking system. Presence of air in the front and rear brake circuit.

Contact an **Authorised Service Centre**.

## **INEFFICIENT SUSPENSION**

Shock absorber fault, oil leak, end buffers damaged; shock absorber preloading incorrectly set

Contact an **Authorised Service Centre**.

## **AUTOMATIC TRANSMISSION PROBLEMS**

CVT rollers and/or drive belt damaged

Contact an **Authorised Service Centre**.

# LUM Beverly Sport Touring ABS- ASR



**PIAGGIO®**



**Chap. 04**  
**Technical data**

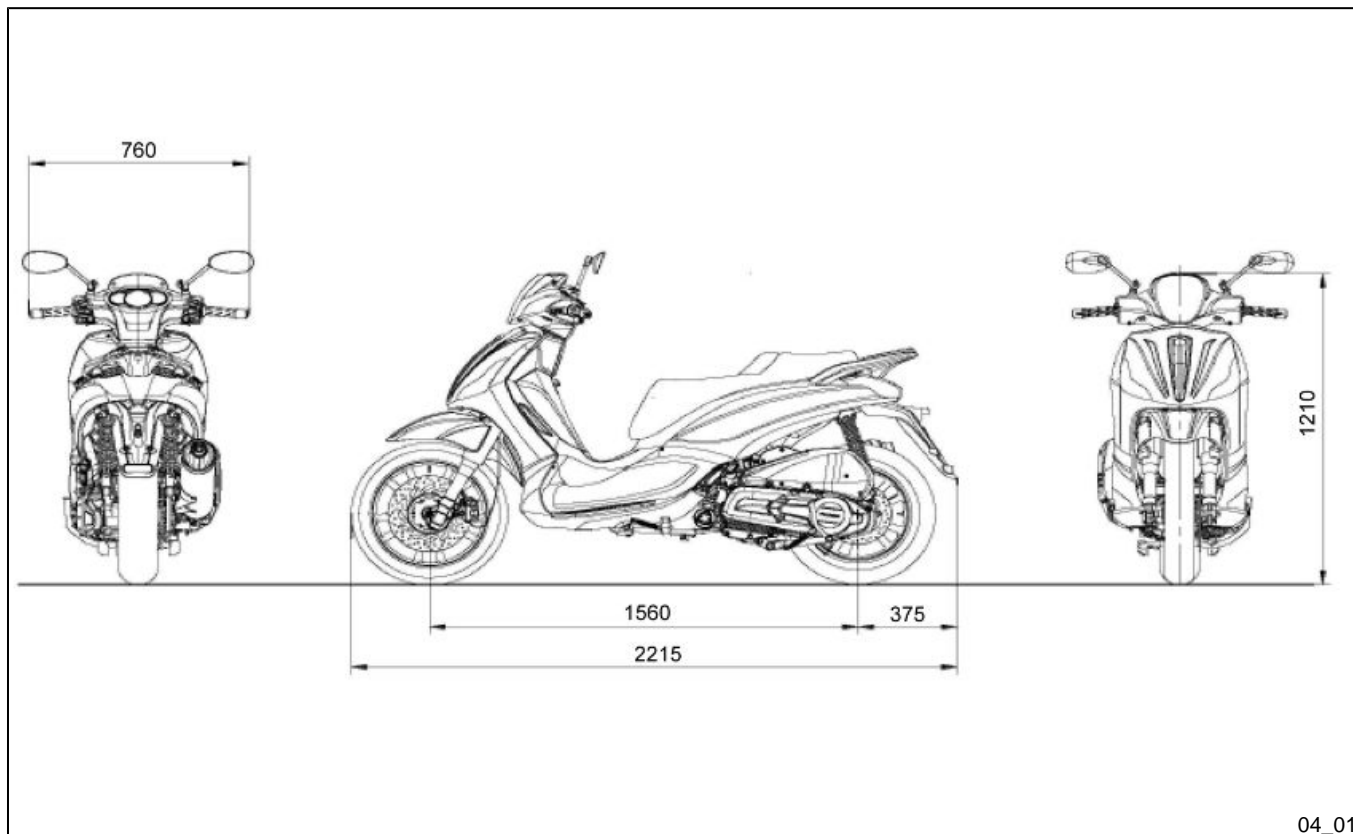

**ENGINE TECHNICAL DATA**

Type	Single-cylinder, 4-stroke
Engine capacity	330 cm <sup>3</sup>
Bore x stroke	78 x 69 mm
Compression ratio	12.0±0.5
Engine idle speed	1700±100 rpm
Timing system	Four valves, single overhead camshaft, chain-driven.
Valve clearance	Intake: 0.10 mm Exhaust: 0.15 mm
Max. power to the shaft	24.5 kW at 8250 rpm
MAX. torque	32.3 Nm at 6250 rpm
Transmission	With continuously variable transmission, torque server, V belt, centrifugal automatic clutch in oil bath.
Final reduction gear	Gear reduction unit in oil bath.
Lubrication	Engine lubrication with trochoidal pump (inside the crankcase), oil filter and pressure adjustment by-pass.
Cooling	Forced coolant circulation system.

Electric	Electric starter
Ignition	Electronic, inductive, high efficiency ignition, integrated with the injection system, with variable advance and separate H.V. coil.
Ignition advance	Three-dimensional map managed by control unit
Fuel system	IAWM3G electronic injection with 38 mm diameter throttle body, electric fuel pump.
Spark plug	NGK CR7EKB
Fuel	Unleaded petrol (95 RON)
Silencer	Absorption-type exhaust silencer with a three-way catalytic converter and lambda probe to the exhaust.
Emissions compliance	EURO 3

### **VEHICLE TECHNICAL DATA**

Chassis	Tubular and steel sheets.
Front suspension	Hydraulic telescopic fork with Ø 35-mm stem
Rear suspension	Two double-acting shock absorbers, adjustable to four positions at preloading.

Front brake	Ø 300-mm disc brake with hydraulic control activated by handlebar right-side lever; braking assisted by ABS system.
Rear brake	Ø 240-mm rear disc brake with hydraulic control operated by the handlebar left-side lever; braking assisted by ABS system.
Wheel rim type	Light alloy wheel rims.
Front wheel rim	Die-cast aluminium alloy, 2.15 x16"
Rear wheel rim	Die-cast aluminium alloy 2.75 x14"
Front tyre	110/70 - 16" M/C 52S Tubeless
Rear tyre	150/70 - 14" M/C 66S Tubeless
Front tyre pressure (with passenger)	2.2 bar (2.2 bar)
Rear tyre pressure (with passenger)	2.4 bar (2.6 bar)
Kerb weight	179 kg ± 8 kg
Maximum weight allowed	375 kg
Battery	SEALED 12V/10Ah

### **CAPACITY**

Engine oil	about 1.5 l
------------	-------------

Transmission oil	about 500 cc
Cooling system fluid	1.75 l
Fuel tank	13 l ± 1

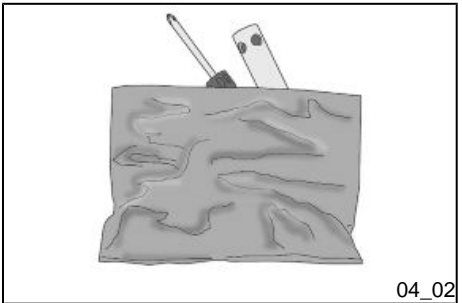

**Toolkit (04\_02, 04\_03)**

The tools are stored under the saddle.

The toolkit includes:

- One box-spanner
- One twin screwdriver
- One special key for adjusting rear shock absorbers
- An extractor for fuses
- One lever for box-spanner
- One double torx wrench





# LUM Beverly Sport Touring ABS- ASR



**PIAGGIO®**



**Chap. 05**  
**Spare parts and**  
**accessories**



## Warnings (05\_01)

### WARNING



TO PREVENT ACCIDENTS AND TO GUARANTEE PROPER STABILITY, PERFORMANCE AND SAFETY, RIDE THE VEHICLE VERY CAREFULLY WHEN IT IS FITTED WITH ACCESSORIES OR WITH UNUSUAL LOADS.

### WARNING



IT IS ALSO RECOMMENDED THAT ORIGINAL PIAGGIO SPARE PARTS BE USED, AS THESE ARE THE ONLY ONES OFFERING YOU THE SAME QUALITY GUARANTEE AS THOSE INITIALLY FITTED ON THE SCOOTER. THE USE OF NON-ORIGINAL SPARE PARTS RENDERS THE WARRANTY VOID.

### WARNING



PIAGGIO MARKETS ITS OWN LINE OF ACCESSORIES THAT ARE RECOGNISED AND GUARANTEED FOR USE. IT IS THEREFORE ESSENTIAL TO CONTACT AN AUTHORISED DEALER OR SERVICE CENTRE IN ORDER TO CHOOSE AND FIT ACCESSORIES CORRECTLY. THE USE OF NON-ORIGINAL ACCESSORIES MAY AFFECT THE STABILITY AND OPERATION OF YOUR VEHICLE AND REDUCE SAFETY LEVELS WITH POTENTIAL RISKS FOR THE RIDER.



NEVER RIDE THE VEHICLE EQUIPPED WITH ACCESSORIES (PANNIERS, TOP BOX AND/OR WINDSHIELD) AT A SPEED HIGHER THAN 110 km/h.

**THE VEHICLE CAN BE RIDDEN AT A HIGHER SPEED WITHOUT THE ACCESSORIES MENTIONED BEFORE WITHIN THE LIMITS ESTABLISHED BY LAW.**

**IF THERE ARE ANY NON-PIAGGIO ACCESSORIES INSTALLED, OR AN ABNORMAL LOAD, OR IF THE SCOOTER IS NOT IN A GENERALLY GOOD CONDITION, OR WHENEVER WEATHER CONDITIONS DEMAND IT, SPEED SHOULD BE FURTHER REDUCED.**

**WARNING**



**BE EXTREMELY CAREFUL WHEN INSTALLING AND REMOVING THE MECHANICAL ANTITHEFT DEVICE ON THE VEHICLE (U-SHAPED PADLOCK, DISC BLOCK, ETC.).**

**MAINLY NEAR THE BRAKE PIPES, TRANSMISSIONS AND/OR ELECTRIC CABLES, AN INCORRECT INSTALLATION OR REMOVAL OF THE ANTITHEFT DEVICE AS WELL AS LEAVING IT ON BEFORE STARTING THE VEHICLE CAN SERIOUSLY DAMAGE ITS COMPONENTS, COMPROMISE THE CORRECT FUNCTIONING OF THE VEHICLE AND USERS' SAFETY.**



# LUM Beverly Sport Touring ABS- ASR



**PIAGGIO®**



**Chap. 06  
Scheduled  
maintenance**



## Scheduled servicing table (06\_01)

Adequate maintenance is fundamental to ensuring long-lasting, optimum operation and performance of your vehicle.

To this end, a series of checks and maintenance operations (at the owner's expense) have been suggested, which are included in the summary table on the following page. Any minor faults should be reported without delay to an **Authorised Service Centre or Dealer** without waiting until the next scheduled service to solve it.

It is indispensable to have your vehicle serviced to the prescribed intervals of time, even if you have not reached the predicted mileage. Punctual vehicle servicing is necessary for the correct use of the guarantee. For all further information regarding the Guarantee application modes and the execution of the "Programmed Maintenance" refer to the "Guarantee Booklet".

### SCHEDULED MAINTENANCE TABLE

km x 1.000	1	10	15	20	30	40	45	50	60
Safety fasteners	I	I		I	I	I		I	I
Spark plug		R		R	R	R		R	R
Centre stand bracket	L	L		L	L	L		L	L
Drive belt				R		R			R
Throttle control	I	I		I	I	I		I	I
Roller housing / Roller counter				C/I		C/I			C/I
Engine air filter (*)		C		C	C	C		C	C
Engine oil filter	R	R		R	R	R		R	R
Belt compartment filter(*)		C		C	C	C		C	C
Valve clearance						I			

km x 1.000	1	10	15	20	30	40	45	50	60
Electrical system and battery	I	I		I	I	I		I	I
Coolant (****)	I	I		I	I	I		I	I
Brake fluid (****)	I	I		I	I	I		I	I
Engine oil (**)	R	R		R	R	R		R	R
Hub oil	R					I			
Brake pads	I	I		I	I	I		I	I
CVT sliders and rollers				R		R			R
Brake pumps			R		R		R		R
Tyre pressure and wear	I	I		I	I	I		I	I
Vehicle road test	I	I		I	I	I		I	I
Crankcase breather (***)				C		C			C
Suspension	I	I		I	I	I		I	I
Steering	A	I		I	I	I		I	I

**I:** CHECK AND CLEAN, ADJUST, LUBRICATE OR REPLACE IF NECESSARY.

**C:** CLEAN, **R:** REPLACE, **L:** LUBRICATE, **A:** ADJUST

\* Perform maintenance more frequently when riding in unusually wet or dusty areas

\*\* Check, however, the level every time you use your vehicle

\*\*\* Perform maintenance more frequently if you drive mainly at full acceleration

\*\*\* Replace every 2 years

## RECOMMENDED PRODUCTS TABLE

Product	Description	Specifications
AGIP GEAR SAE 80W-90	Lubricant for gearboxes and transmissions.	API GL-4
AGIP FILTER OIL	Special product for the treatment of foam filters.	-
AGIP GP 330	Water repellent stringy calcium spray grease.	R.I.D./A.D.R. 2 10°b) 2 R.I.Na. 2.42 - I.A.T.A. 2 - I.M.D.G. class 2 UN 1950 Pag. 9022 EM 25-89
eni i-Ride scooter 15W-50	Synthetic-based lubricant for four stroke engines.	JASO MA, MA2 - API SJ - ACEA A3
AGIP BRAKE 4	Brake fluid.	Synthetic fluid SAE J 1703 - FMVSS 116 - DOT 3/4 - ISO 4925 - CUNA NC 956 DOT 4
AGIP PERMANENT SPECIAL	Ethylene glycol-based antifreeze fluid with organic inhibition additives. Red, ready to use.	ASTM D 3306 - ASTM D 4656 - ASTM D 4985 - CUNA NC 956-16

### UNIT OF MEASURE - CONVERSION - ENGLISH SYSTEM TO INTERNATIONAL SYSTEM (IS).

1 Inch (in)	25.4 Millimetres (mm)
1 Foot (ft)	0.305 Meter (m)
1 Mile (mi)	1.609 Kilometre (km)
1 US Gallon (USgal)	3.785 Litre (l)
1 Pound (lb)	0.454 Kilogram (kg)
1 Cubic inch (in <sup>3</sup> )	16.4 Cubic centimetres (cm <sup>3</sup> )
1 Foot pound (ft lb)	1,356 Newton meter (Nm)



1 Miles per hour (mi/h)	1.602 Kilometres per hour (km/h)
1 Pound per square inch (PSI)	0.069 (bar)
1 Fahrenheit (°F)	$32 + (9/5)$ Celsius (°C)

## 6 Scheduled maintenance

# TABLE OF CONTENTS

## **A**

ABS: 17  
Air filter: 55, 56

## **B**

Battery: 63, 64  
Brake: 59, 76

## **C**

Checks: 34  
Clock: 11

## **D**

Disc brake: 76  
Display: 13

## **E**

Engine oil: 48–50  
Engine stop: 17

## **F**

Fuel: 27  
Fuses: 66

## **H**

Headlight: 71  
Horn: 15  
Hub oil: 51

## **I**

Identification: 28  
Immobilizer: 23–25  
Instrument panel: 9

## **K**

Key switch: 13  
Keys: 23

## **L**

Light switch: 16

## **M**

Maintenance: 47, 93  
Mirrors: 75

## **P**

Puncture: 77

## **R**

Refuelling: 34

## **S**

Saddle: 28  
Scheduled maintenance: 93  
Shock absorbers: 37  
Spark plug: 54  
Stand: 41

Start-up: 16

Switch: 13, 15, 16

## **T**

Tank: 27  
Technical Data: 83  
Toolkit: 88  
Top box: 30  
Transmission: 42  
Tyre pressure: 36  
Tyres: 53

## **V**

Vehicle: 7, 78



The descriptions and images in this publication are given for illustrative purposes only and are not binding. While the basic characteristics as described and illustrated in this booklet remain unchanged, Piaggio & C. S.p.A. reserves the right, at any time and without being required to update this publication beforehand, to make any changes to components, parts or accessories, which it considers necessary to improve the product or which are required for manufacturing or construction reasons.

Not all versions/models shown in this publication are available in all countries. The availability of each model should be checked at the official PIAGGIO sales network.

© Copyright 2012 - Piaggio & C. S.p.A. All rights reserved. Reproduction of this publication in whole or in part is prohibited.

Piaggio & C. S.p.A. Viale Rinaldo Piaggio, 25 - 56025 PONTEDERA (PI), Italy

[www.piaggio.com](http://www.piaggio.com)